

Date: 23-03-2026

To,
The Divisional Forest Officer
Aie Valley Forest Division, Assam.

Sub: Proposal for diversion of 61.6 ha (19.187 ha in Aie Valley Division, 41.747 in Goalpara Division, 0.666 ha in Haltugaon Division) forest area for construction of 400 kV D/C Bongaigaon-Nangalbibra Transmission line– *submission of pointwise compliance report of the in-principle approval and request for processing the proposal for issuance of final approval.*

Ref:

1. In-Principle approval accorded by the MoEFCC, IRO Gandhinagar vide F. No. 3-AS B 157/2023-GHY/3649-50, dated 28.02.2023.
2. Demand note raised by the DFO, Aie Valley Forest Division, vide letter No. A/AVD/400KV/718-20, dated 13.03.2023.
3. Demand letter of the PCCF Wildlife and Chief Wildlife Warden, Assam vide No. WL/FG/Proposal/Bongaigaon-Nangalbibra Trans line, dated 23.05.2025.
4. Demand letter raised by the DFO, Aie Valley Division, Bongaigaon vide letter no. B/AVD/Sterlite/400kv/2025/3833, dated 08.07.2025.

Dear Sir,

With reference to the above, please find enclosed the revised pointwise compliance report of the In- principle approval accorded by the MoEFCC, IRO Shillong vide F. No. 3-AS B 157/2023-GHY/3649- 50, dated 28th February 2023 along with necessary enclosures.

All the compensatory levies have been deposited to the Ad-hoc CAMPA Account and the given account of the DFO, Aie Valley which are tabulated below for ready reference.

Txn Posted Date	UTR No./ Description	Payment head	Transaction Amount (INR)
10/04/2023	RTGS:ICICR52023041000244178 /UBIN0996335/ASSAMCAMP	NPV, CA, Medicinal Plantation in CAMPA through e-challan	5,96,59,843



NANGALBIBRA-BONGAIGAON TRANSMISSION LIMITED

DLF Cyber Park Tower-B, 9th Floor, Udyog Vihar Phase-III,
Sector-20, Gurugram-122008, Haryana India +91 0124 4562 000



27/04/2023	TRFR NO.070805000767	Erection of boundary pillars	23,43,047
12/08/2024	M3598793	Additional 365 Nos. tree operation cost.	28,55,149
13/03/2026	UTR No. HDFCR52026031381539908 CAMPA	Wildlife Conservation and Management Plan	1,10,13,814
20/03/2026	NEFT Ref No. NBTL200326R1 DFO, Aie Valley	Cost of Plantation of Fruits tree for Golden Langur	73,03,855
20/03/2026	NEFT Ref No. NBTL200326R1 DFO, Aie Valley	10 Nos JFMC for 5 years	4,65,25,000

In view of the above, you are requested to process the compliance report for issuance of the final approval from the competent authority.

Thanking You,

Nangalbibra-Bongaigaon Transmission Ltd



(Authorized Signatory)

Narottam Chakraborty
Head- Forest & Wildlife

Copy to:

1. The Chief Conservator of Forests and the Nodal Officer (FC Act), Assam, Guwahati for kind information please.

Encl: Pointwise compliance report along with the enclosures.

COMPLIANCE REPORT

Pointwise compliance of the in-principle approval No. 3-AS B157/2023-GHY/3649-50, dated 28.02.2023 of the MoEF&CC, IRO Guwahati, for the diversion of 61.6 ha of forest land for construction of 400 kV D/C Bongaigaon to Nangalbibra Transmission line under Haltugaon, Aie Valley, and Goalpara Forest divisions.

A. Conditions need to be complied with prior handing over of forest- land by the State Forest Department:

Sl. No.	Conditions as per In-Principle approval vide F.No. 3-AS B 157/2023-GHY/3649-50	Compliance
1	<p>The User Agency shall transfer, the Net Present Value (NPV) of the forest land being diverted under this proposal as per the orders of the Hon'ble Supreme Court of India dated 28/03/2008, 24/04/2008 and 09/05/2008 in Writ petition (Civil) No. 202/1995 and as per guidelines issued by the Ministry vide letters No. 5-3/2007- FC, dated 05.02.2009 and File No. 5-3/2011FC(Vol-I), dated 21.03.2022. The requisite funds shall be transferred through online portal into CAMPA account of the State concerned.</p>	<p>Aie Valley Forest Division- The NPV amounting Rs. 8,61,039/- has been deposited in CAMPA account vide UTR No: ICICR52023041000244178 /UBIN099 6335/ASSAM CAMPA, dated 10.04.2023 reference to letter No. A/AVD /400KV/718-20, dated 13.03.2023 of the Divisional Forest Officer, Aie Valley forest division.</p> <p>Haltugaon Forest Division- The NPV amounting Rs. 2,75,65,387.30/- has been deposited in CAMPA account vide UTR No: ICICR52023041000244178/UBIN0996335/ASSAM CAMPA, dated 10.04.2023 reference to letter No. B/HFD/LD/NBTL/3653, dated 04.03.2023 of the Divisional Forest Officer, Haltugaon Forest Division</p> <p>Goalpara Forest Division- The NPV amounting Rs. 4,66,27,225/- has been deposited in CAMPA account vide UTR No: ICICR52023041000244178/UBIN0996335/ASSAM CAMPA, dated 10.04.2023 reference to letter No. B/GLP/ DFO(T) /FCA /Diversion proposal/Sterlite Power/1402, dated 13.03.2023 of the Divisional Forest Officer, Goalpara Forest Division.</p> <p>Online payment confirmation is enclosed as Annexure-I.</p>
2	<p>The User agency shall transfer the cost of raising and maintaining the Compensatory Afforestation at the current wage rate in consultation with State Forest Department in the account of CAMPA of the concern state through online portal. The Scheme may include appropriate provision for anticipated cost increase for work scheduled for subsequent years.</p>	<p>Aie Valley Forest Division- The cost of Compensatory Afforestation amounting Rs. 2,72,71,634.34/- has been deposited in CAMPA account vide UTR No: ICICR52023041000244178/UBIN0996335/ASSAM CAMPA, dated 10.04.2023 in reference to letter No. A/AVD/ 400KV/718-20, dated 13.03.2023 of the Divisional Forest Officer, Aie Valley forest division.</p> <p>Haltugaon Forest Division- The cost of Compensatory Afforestation amounting Rs. 33,94,500/- has been deposited in CAMPA account vide UTR No: ICICR52023041000244178/UBIN099633 5/ASSAM CAMPA, dated 10.04.2023 in reference to letter No. B/HFD/LD/NBTL/3653, dated 04.03.2023 of the Divisional Forest Officer, Haltugaon Forest Division.</p> <p>Goalpara Forest Division- The cost of Compensatory Afforestation amounting Rs. 6,55,60,057/- has been deposited in CAMPA account vide UTR No. ICICR52023041000244178/UBIN099633 5/ASSAMCAMP A, dated 10.04.2023 in reference to letter No.B/GLP/DFO(T) /FCA/Diversion Proposal/Sterlite Power/1402, dated 13.03.2023 of the Divisional Forest Officer, Goalpara Forest Division.</p> <p>Online payment confirmation is enclosed as Annexure-I.</p>



3	All the funds received from the user agency (CA and dwarf plantation cost, NPV etc.) under the project shall be transferred/deposited to compensatory Afforestation Fund of Assam State managed by the Ad-hoc CAMPA only through e-portal (https://parivesh.nic.in/). Amount deposited through other mode will not be accepted as compliance of Stage-I clearance.	The total amount of Rs. 191845839/- has been deposited in CAMPA account vide UTR No: ICICR52023041000244178/UBIN0996335/ASS AMCAMPA, dated 10.04.2023 in reference to the demand note of concerned Divisional Forest Officers, Assam. Online payment confirmation is enclosed as Annexure-I .
4	The KML files of the area to be diverted, the CA areas, the proposed SMC work, the proposed Catchment Area Treatment area and the WLMP area shall be uploaded on the e-Green watch portal with all requisite details before issuing working permission towards linear projects or submitting compliance report for seeking Stage-II approval, as the case may be.	Noted and shall be ensured.
5	The boundary of the diverted forest land shall be suitably demarcated on ground at the project cost, as per the direction of the concerned Divisional Forest Officer	<p>Aie Valley Forest Division- The boundary of the diverted forest land has been demarcated on ground at project cost by forest department. The amount of Rs. 7,69,850/- has been deposited in this regard at ICICI bank account no. 070805000767 as directed by the DFO, Aie Valley vide letter no. B/AVD/400KV/2156, dated 06/06/2023.</p> <p>Haltugaon Forest Division- The cost of Rs. 10,10,000/- for departmental operation of trees & boundary pillars, has been deposited, as directed by DFO, Haltugaon vide letter No.B/HFD/LD/NBTL/430, dated 07.05.2023.</p> <p>Goalpara Forest Division- The cost of Rs. 69,49,246/- for Departmental operation of trees & boundary pillars, has been deposited, as directed by DFO, Goalpara vide Letter No. B/GLP/DFO(T)/Diversion Proposal/Sterlite Power/2021, dated 17.04.2023.</p> <p>Photographs are enclosed as Appendix -I</p>
6	The user agency shall deposit 2% of the total project cost for Human Elephant Conflict mitigation and wildlife conservation purposes and the amount shall be deposited into account of CAMPA.	Reference to the demand letter of the PCCF Wildlife and Chief Wildlife Warden, Assam vide No. WL/FG/Proposal/Bongaigaon-Nangalbibra Trans line, dated 23.05.2025 the cost for Human Elephant Conflict mitigation and wildlife conservation purposes an amount of Rs.1,10,13,814/- (One Crore Ten Lakhs Thirteen Thousand Eight Hundred and Fourteen only) has been deposited in Ad-hoc CAMPA Account vide UTR No-HDFCR52026031381539908, dated 13.03.2026. The copy of above demand letter and payment details are enclosed as Annexure-I A .
7	The State Govt shall ensure that under no circumstances, implementation of such mitigation measures envisaged in Human Elephant/ Wildlife Conflict mitigation and wildlife conservation plan should be delayed beyond a period of 2 years to ensure commencement of rejuvenation of ecosystem services lost from the forest area allowed for non- forestry use of forest land at the earliest possible time	Noted.
8	The State Govt shall submit Human Elephant/wildlife Conflict mitigation and wildlife conservation plan approved by	As per demand letter received from the PCCF Wildlife and Chief Wildlife Warden, Assam vide No. WL/FG/Proposal/Bongaigaon-Nangalbibra Trans line, dated 23.05.2025 and demand letter of the

	<p>Chief Wildlife Warden, Govt. of Assam along with detail cost of its implementation.</p>	<p>DFO, Aie Valley Division, dated 08.07.2025 amount of Rs. Rs.1,10,13,814/- has been deposited in Ad-hoc CAMPA Account vide UTR No- HDFCR52026031381539908, dated 13.03.2026 and Rs.5,38,28,855/- has been deposited to the bank account of the DFO, Aie Valley Division, through NEFT vide Ref No. NBTL200326R1 dated 20.03.2026.</p>
<p>9</p>	<p>The State Govt. shall ensure to comply strictly to the following recommendation of the CWLW, Govt. of Assam: -</p> <p>a. Ground clearance shall be minimum of 15 m as proposed by the UA.</p> <p>b. Three-layer protection measures will be adopted to ensure complete safety and minimum interference with fauna. The measures include barbed fencing of tower area, Special tower design having soft material anti-climbing guards & anti-climbing canopy which will restrict any arboreal animals from climbing on towers.</p> <p>c. User Agency shall prepare and submit WL Management Plans suggested by Forest & WL Department.</p> <p>d. The User agency shall do plantation of fruit trees especially for Golden Langur in and around the Golden Langur habitat area through forest department.</p> <p>e. The user agency shall provide fund and support 10 Nos. of JFMCs for five years in and around Bhairab RF and other nearby forest which are habitat for Golden Langur for taking up Entry point Activity, livelihood activities, ecotourism facilities and capacity building for local youth.</p> <p>f. Felling of trees will be restored only at proposed tower locations and other areas shall be avoided.</p>	<p>All the mentioned conditions will be complied with.</p> <p>a. Ground clearance has been maintained minimum of 15 m along the route in Bhairab RF.</p> <p>b. Three-layer protection measures have been adopted at all the towers in Bhairab RF. Photographs enclosed as Appendix II.</p> <p>c. Reference to the demand letter of the PCCF Wildlife and Chief Wildlife Warden, Assam vide No. WL/FG/Proposal/Bongaigaon-Nangalbibra Trans line, dated 23.05.2025 the cost for Human Elephant Conflict mitigation and wildlife conservation purposes an amount of Rs.1,10,13,814/- (One Crore Ten Lakhs Thirteen Thousand Eight Hundred and Fourteen only) has been deposited in Ad-hoc CAMPA Account vide UTR No-HDFCR52026031381539908, dated 13.03.2026. The copy of above demand letter and payment details are enclosed as Annexure-I A.</p> <p>d. The cost of plantation of fruit trees especially for Golden Langur in and around the Golden Langur habitat area amounting to Rs. 73,03,855/- (Rs. Seventy Three Lakhs Three Thousand and Eight Hundred and Fifty Five only) has been deposited to the bank account of the DFO, Aie Valley Division, Bongaigaon through NEFT vide Ref No. NBTL200326R1, dated 20.03.2026 against demand letter raised from the DFO, Aie Valley Division, Bongaigaon, dated 08.07.2025. The copy of above demand letter and payment details are enclosed as Annexure -I A.</p> <p>e. The cost of supporting 10 Nos of JFMCs for five years in and around Bhairab RF and other nearby forest amounting to Rs. 4,65,25,000/- (Rs. Four Crore Sixty-Five Lakhs and Twenty Five Thousand only) has been deposited to the bank account of the DFO, Aie Valley Division, Bongaigaon through NEFT vide Ref No. NBTL200326R1, dated 20.03.2026 against demand letter raised from the DFO, Aie Valley Division, Bongaigaon, dated 08.07.2025. The copy of above demand letter and payment details are enclosed as Annexure -I A.</p> <p>f. Felling of trees have been restricted at the tower locations and bare minimum in the corridor to maintain safe electrical clearance as per Indian standard.</p>
<p>10</p>	<p>The user agency shall explore the possibility of successful translocation of maximum number of trees identified to be felled shall be explored and any tree felling shall be done only when it is unavoidable and that too under strict supervision of the State Forest department.</p>	<p>Translocation of trees have been explored, and unavoidable trees were only felled by the forest department.</p>



11	The charges for felling, logging and transportation of project affected trees should be collected from the User Agency at the rates approved by the State Govt and deposited with the DFO concerned for utilization immediately following the diversion of forest land.	<p>Aie Valley Forest Division- The cost of Departmental operation of trees has been deposited in the ICICI bank account no. 070805000767 as directed by the DFO, Aie Valley vide letter No. B/AVD/400KV/2156, dated 06/06/2023.</p> <p>Haltugaon Forest Division- The cost of Rs. 10,10,000/- for departmental operation of trees & boundary pillars, has been deposited, as directed by the DFO, Haltugaon vide letter No.B/HFD/LD/NBTL/430, dated 07.05.2023.</p> <p>Goalpara Forest Division- The cost of Rs. 69,49,246/- for Departmental operation of trees & boundary pillars, has been deposited, as directed by the DFO, Goalpara vide letter No. B/GLP/DFO(T)/Diversion Proposal/Sterlite Power/2021, dated 17.04.2023.</p>
12	The expenditure like boundary walls, stone pillars, demarcation charges, cost of damage of trees the funds on these accounts should be deposited with the DFO concerned.	<p>Aie Valley Forest Division- The cost of boundary pillars and Departmental operation of trees has been deposited in the ICICI bank account no. 070805000767 as directed by the DFO, Aie Valley vide Letter No. B/AVD/400KV/2156, dated 06.06.23 & B/AVD/400KV/BNG to Nagalbibra/2024/3364, dated 08.08.24.</p> <p>Haltugaon Forest Division- The cost of Rs. 10,10,000/- for departmental operation of trees & boundary pillars, has been deposited, as directed by the DFO, Haltugaon vide letter No.B/HFD/LD/NBTL/430, dated 07.05.2023.</p> <p>Goalpara Forest Division- The cost of Rs. 69,49,246/- for Departmental operation of trees & boundary pillars, has been deposited, as directed by the DFO, Goalpara vide letter No. B/GLP/DFO(T)/Diversion Proposal/Sterlite Power/2021, dated 17.04.2023.</p>
13	The User Agency shall restrict the felling of trees to minimum number in the diverted forest land and the trees will be felled under the strict supervision of the State Forest Department, and the cost of felling of trees has been deposited to the state Forest Department.	Unavoidable trees were only felled by Forest Department & cost of felling has been deposited as per demand of all the concerned DFO.
14	The complete compliance of the FRA, 2006 shall be ensured by way of prescribed certificate from the concerned District Collector.	The complete compliance of the FRA, 2006 have been completed in all three districts. FRA certificates enclosed as Annexure-III .
15	Violation of any of these conditions will amount to violation of Forest (conservation) Act, 1980 and action would be taken as prescribed in para 1.21 of chapter 1 of the Handbook of comprehensive guidelines of Forest (conservation) Act, 1980 as issued by this Ministry's letter No. 5-2/2017-Fc dated 28.03.2019.	Agreed. Undertaking in this regard is enclosed as Annexure-II .
16	The User Agency in consultation with the State Forest Department prepare a detailed scheme for creation and maintenance of plantation of dwarf species (preferably medicinal plants) in right of way under the transmission line for execution of the said scheme to the State Forest Department.	Aie Valley Forest Division- The detailed scheme for creation and maintenance of plantation of dwarf species in right of way under the transmission line has been prepared. The cost of Dwarf Plantation Rs. 48,22,821/- has been deposited in CAMPA account vide UTR No: ICICR52023041000244178/UBIN099633/ASSAM CAMPA, dated 10.04.2023 in reference to letter No. A/AVD/400KV/718-20, dated 13.03.2023 of the Divisional Forest Officer, Aie Valley forest division.

		<p>Haltugaon Forest Division- The detailed scheme for creation and maintenance of plantation of dwarf species in right of way under the transmission line has been prepared. The cost for Dwarf Plantation Rs. 16,54,000/- has been deposited in CAMPA account vide UTR No: ICICR52023041000244178/UBIN0996335/ASSAM CAMPA, dated 10.04.2023 in reference to letter No. B/HFD/LD/NBTL/3653, dated 04.03.2023 of the Divisional Forest Officer, Haltugaon Forest Division.</p> <p>Goalpara Forest Division- The detailed scheme for creation and maintenance of plantation of dwarf species in right of way under the transmission line has been prepared. The cost for Dwarf Plantation Rs. 1,40,89,175/- has been deposited in CAMPA account vide UTR No: ICICR52023041000244178/UBIN099633/ASSAM CAMPA, dated 10.04.2023 in reference to letter No.B/GLP/DFO(T)/FCA/Diversion Proposal/ Sterlite Power/1402, dated 13.03.2023 of the Divisional Forest Officer, Goalpara Forest Division.</p> <p>Online payment confirmation enclosed as Annexure-I.</p>
17	The compliance report shall be uploaded on -e-portal (https://parivesh.nic.in)	Noted and shall be complied.

B. Conditions need to be strictly complied on field after handing over of forest- land to the user agency by the State Forest Department but the compliance in form of undertaking shall be submitted prior to Stage-II approval:

Sl. No.	Conditions as per In- Principle approval vide F.No. 3-AS B 157/2023-GHY/3649-50	Compliance
1	Legal status of forest land proposed for diversion shall remain unchanged.	Agreed. Undertaking in this regard is enclosed as Annexure-II .
2	The compensatory Afforestation shall be taken up on doubled the degraded forest land of 125.35 ha which has been identified in three different patches i.e. 1.35 ha in Nayekgaon Range, Haltugaon Forest Division in Kokrajhar district; 84 ha in Lakhipur Range in Nalbari RF (10 ha), Central Range, Krishnai, Zengrazanga (39 ha), Central Krishnai Zengrazanga (25 ha), Rongjuli Dolngdo Reserve Forest (10 ha) in Goalpara District; and 40 ha in Abhayapuri Range, Aie vally Forest Division in Bongaigaon District of Assam within three years from the date of Stage-II clearance and maintained thereafter by the State Forest Department at the cost of the User Agency. As far as possible, a mixture of local indigenous species shall be planted, and monoculture of any species may be avoided. The CA will be maintained for 10 years.	Cost for raising Compensatory Afforestation for all the locations in three Forest Divisions has been deposited in CAMPA account vide UTR No: ICICR52023041000244178/UBIN0996335/ASSAM CAMPA, dated 10.04.2023. Online payment confirmation enclosed as Annexure-I
3	At the time of payment of the Net Present Value (NPV) at the time of prevailing rate, the User Agency shall furnish an undertaking to pay the additional amount of NPV, if so determined, as per final decision of the Hon'ble Supreme Court of India	Agreed. Undertaking in this regard is enclosed as Annexure-II .
4	The User Agency shall obtain the Environment Clearance as per the provisions of Environment (Protection) Act, 1986, if required (NA).	Not applicable for transmission line projects.
5	No labour camp shall be established on the forest land and fuels preferably the alternated fuel to labourers and the staff working at the site shall be provided so as to avoid any damage and pressure on the nearby forest areas.	Agreed. Undertaking in this regard is enclosed as Annexure-II .
6	The forest land proposed to be diverted shall under no circumstances be transferred to any other agencies.	Agreed. Undertaking in this regard is enclosed as Annexure-II .

	department, or person without prior approval of the Govt. of India.	
7	No damage to the flora and fauna of the adjoining areas shall be caused.	Shall be complied. Undertaking in this regard is enclosed as Annexure-II .
8	The layout of the proposal shall not be changed without prior approval of the central Govt.	Agreed. Undertaking in this regard is enclosed as Annexure-II .
9	The concerned Divisional Forest Officer will monitor and take necessary mitigative measures to ensure that there is no adverse impact on the forests in the surrounding Area.	Noted.
10	The User Agency at its cost shall provide bird deflectors which are to be fixed on the upper conductor of transmission line at suitable interval to avoid bird hits.	The bird deflectors have been installed on the upper conductor of transmission line at suitable interval. Photographs enclosed as Appendix III .
11	The User Agency shall comply all the provision of all Acts, Rules, Regulations, Guidelines, Hon'ble Court Order(s) and NGT Order(s) pertaining to this project, if any, for the time being in force as applicable to the project	Agreed. Undertaking in this regard is enclosed as Annexure-II .
12	The User Agency shall comply with the guidelines for laying transmission through forest areas issued by Ministry vide letter No. 7-25/2012-FC, dated 5/05/2014 & 19/11/2014.	Agreed. Undertaking in this regard is enclosed as Annexure-II .
13	No additional or new path will be constructed inside the forest area for transportation of construction materials for execution of the project work.	Agreed. Undertaking in this regard is enclosed as Annexure-II .
14	The period of diversion under this approval shall be co-terminus with the period of lease to be granted in favour of the user agency or the project life, whichever is less.	Agreed.
15	The forest land shall not be used for any purpose other than that specified in the project proposal.	Agreed. Undertaking in this regard is enclosed as Annexure-II .
16	As per Ministry's letter no 11-30/96-FC (Pt) dt. 14.9.2001 if the compliance of stipulated conditions is awaited from the State Govt for more than 5 (five) years, the in-principle approval would be summarily revoked considering that the user agency is no longer interested in the project.	Agreed.
17	Any other conditions that the Integrated Regional Office, Guwahati, MoEFCC may be stipulated from time to time in the interest of conservation protection and development of Forest & Wildlife	Agreed.

Date: 23/03/2026

Signature:



Name: Narottam Chakraborty

Designation: Head- Forest & Wildlife

Nagalbibra-Bongaigaon Transmission Ltd.

Address of Agency:

Resonia Limited,

5th Floor, RMZ Infinity, Plot No 15

Phase IV, Sec-18, Gurugram, Haryana, 122015.



PARIVESH

 परिवेश

"Pro Active and Responsive facilitation by Interactive, Virtuous and Environmental Singlwindow Hub"

Ministry of Environment, Forest and Climate Change

 Government of India



- [Home](#)
- [My Account](#)
- [My Proposals Environment Clearance](#)
- [Only CRZ Clearance](#)
- [My Proposals Forest Clearance](#)
- [My Proposals Wildlife Clearance](#)
- [Help](#)

3:07:26 PM

Online payment history made by User Agency under CAHPA

Help

Sno.	Proposal Detail	Application_No	Application No (New)	Date of TR-PRINCIPLE	Amount to be Paid/Amount Paid (in Rs.)	Payment Status	Payment Detail	Demand Letter
1	EP/AS/TRANS/152968/2022 Construction of 400 KV DC Bongaijalon Nangalobra Transmission Line	TRANS152968202296894152968966		28 Feb 2023	CA: 96226192/- PCA: 0/- Safety Zone: 0/- NPV: 75053651/- Other Charges1: 0/- Other Charges2: 0/- Other Charges3: 0/- Total: 191645839/-	 Paid	Fund Demand Verified by : 15 Mar 2023 Nodal Officer On : Bank Name : Union Bank Of India Mode of Payment : NIFT/RTGS (Challan) Challan Generated On : 25 Mar 2023 Transaction Date : 11 Apr 2023	Demand Letter Generated Challan











NANGALBIBRA-BONGAIGAON TRANSMISSION LIMITED

DLF Cyber Park Tower-B, 9th Floor, Udyog Vihar Phase-III,
Sector-20, Gurugram-122008, Haryana India +91 0124 4562 000



ANNEXURE- I A

PAYMENT DETAILS

Date	UTR No	Payment Description	Payment Head	Transaction Amount
13/03/2026	UTR No. HDFCR52026031381539908	Wildlife Conservation and Management Plan	CAMPA Assam A/C No. 150617299	1,10,13,814
20/03/2026	NEFT Ref No. NBTL200326R1	Cost of Plantation of Fruits tree for Golden Langur	A/C No. 070805000767	73,03,855
20/03/2026	NEFT Ref No. NBTL200326R1	10 Nos JFMC for 5 years	A/C No. 070805000767	4,65,25,000



(Authorized Signatory)

Narottam Chakraborty
Head- Forest & Wildlife
Nangalbibra Bongaigaon Transmission Ltd.



GOVERNMENT OF ASSAM
OFFICE OF THE PRINCIPAL CHIEF CONSERVATOR OF FORESTS, WILDLIFE AND
CHIEF WILDLIFE WARDEN, ASSAM

Email ID: pccf.wl.assam@gmail.com

No. WL/FG/Proposal/Bongaigaon-Nangalbibra Trans line

Date: **23**.05.2025

To,

The Chief Manger,
Nangalbibra-Bongaigaon Transmission Ltd.,
2nd Floor, Samriddhi Complex, New Market,
Pancharatna Road, Goalpara, Assam-783101.

Sub: Deposition of 2% project cost for Human Elephant/Wildlife Conflict Mitigation & Wildlife Conservation purpose against proposal for “diversion of 61.6 Ha. of forest land for construction of 400 kV D/C Bongaigaon to Nangalbira Transmission Line in Sathbandi RF, Bhairab RF, Pancharatna RF, Sagunbari RF, Zangrazangsa RF, Bogulmari PRF & Rakshashini PRF under haltugaon Division (area-0.66 Ha), Aie Valley Division (area-19.187 Ha) & Goalpara Division (41.747 Ha) by Nangalbibra-Bongaigaon Transmission Ltd”.

Ref: 1. This office letter No. WL/FG/proposal/Bongaigaon-Nangalbibra Trans line, dated 07.06.2023.
2. Your office letter No. NBTL/FOREST/2025-26/01, dated 30.04.2025.

Sir,

Pursuant to the MoEF & CC, Govt of India's F.No. 3 AS B 157/2023-GHY/3649-50, dated 20.02.2023 granting “In Principle Approval/Stage-I” for the above-mentioned proposal and with reference to the subject and letters cited above, it is requested to deposit 2% of the proportionate project cost to the account of CAMPA, as estimated below:

- (a) Total area of the project both in the state of Assam & Meghalaya = 563.772 Ha.
- (b) Total area of project in the state of Meghalaya (non-forest + forest) = 243.496 Ha.
- (c) Total area of the project in the state of Assam (non-forest + forest) = 320.276 Ha.
- (d) Area of forest land proposed for diversion in the state of Assam = 61.6 Ha.
- (e) Proportionate cost of the project in the state of Assam = $320.276/563.772 \times \text{Rs } 504,00,00,000 = \text{Rs } 286,31,98,314/-$
- (f) **2% proportionate project cost** = $61.6/320.276 \times \text{Rs. } 286,31,98,314 \times 2\%$
= Rs 1,10,13,814/-

In view of the above, it is requested to deposit an above-mentioned amount of **Rs 1,10,13,814/- (one crore ten lakhs thirteen thousand eight hundred fourteen only)** for preparation and implementation of Human Elephant/Wildlife Conflict Mitigation & Wildlife Conservation and Management Plan with special emphasis on Golden Langur, in the account of CAMPA.

This is for your kind information and necessary action.

Yours faithfully,



(Dr. Vinay Gupta, IFS)
Principal Chief Conservator of Forests,
Wildlife & Chief Wildlife Warden, Assam.

Copy for information and necessary action to.

1. CCF & Nodal Officer (FC Act), Assam, O/o the PCCF & HoFF, Assam. This has a reference to this office letter No. WL/FG/Proposal/Bongaigaon-Nangalbibra Trans line, dated 26.12.2024 and your letter No. FG.27/FCA/Proposal/Nangalbibra-Bongaigaon Transmission Ltd., dated 18.02.2025.
2. DFO, Goalpara Division, Goalpara, Aie Valley Division, Bongaigaon & Haltugaon Division, Kokrajhar.



Principal Chief Conservator of Forests,
Wildlife & Chief Wildlife Warden, Assam.

Copy for information to Principal Chief Conservator of Forests & Head of Forest Force, Assam, Panjabari, Guwahati-37.



Principal Chief Conservator of Forests,
Wildlife & Chief Wildlife Warden, Assam.



GOVT.OF ASSAM
OFFICE OF THE DIVISIONAL FOREST OFFICER:::AIE VALLEY DIVISION
BONGAIGAON.

E-mail- dfo.t.aievalley@gmail.com

No. B/AVD/Sterlite/400kv/2025/ 3833

Date: 08/07/25

To,

The Chief Manager
Sterlite Power Transmission Limited
2nd Floor, Samriddhi Complex
New Market, Pancharatna Road
Goalpara, Assam-783101

Sub: Demand note for submission of Human Elephant/Wildlife Conflict Mitigation and Wildlife Conservation Plan against the project "Construction of 400 KV DC Nangalbibra-Bongaigaon Transmission Line.

Ref: MoEF & CC Regional Office, Guwahati vide F.No.3 AS B 157/2023 GHY/3649-50, dt. 28.02.2023 &

Your letter No. NBTL/FOREST/2025-26/02, dtd. 06.05.2025

Sir,

With reference to the subject cited above, you are requested to deposit the cost of plantation of fruit bearing species for Golden Langur & fund for 10(ten) nos. J.F.M.C. for implementing different activities within five years around the Bhairab Hill R.F. as per condition no. A.(9)(d) &(e) of the "In Principle Approval/Stage-I" clearance accorded by the Central Government vide Regional Office, Shillong, Ministry of Environment, Forest & Climate Change letter no. F.No. 3 AS B 157/2023 GHY/3649-50, dt. 28.02.2023 against the project "Construction of 400 KV DC Nangalbibra-Bongaigaon Transmission Line. The amount should be deposited in the following Bank Account and the details break up of amount shown below.

- | | | |
|------|---|---------------------------------|
| (i) | Cost of raising plantation for fruit bearing species for Golden Langur | Rs. 73,03,855/- |
| (ii) | Cost of 10(ten) nos. J.F.M.C. for different schemes for five years around the Bhairab Hill R.F. | Rs. 4,65,25,000/- |
| | | Total= Rs. 5,38,28,855/- |

In words: (Rupees Five Crore Thirty Eight Lakh Twenty Eight Thousand Eight hundred Fifty Five) only

Bank Details:

Name of A/C holder : Divisional Forest Officer,
Aie Valley Division, Bongaigaon
Name of Bank : ICICI Bank, Bongaigaon Branch
Account No. : 70805000767
IFSC : ICIC0000708

This is for your kind information and necessary action.

Yours faithfully

Habin
08/07/25
Divisional Forest Officer
Aie Valley Division
Bongaigaon

Date: 08/07/25

No. A/AVD/Sterlite/400kv/2025/ 3583-85

Copy to:

1. The Principal Chief Conservator of Forests, Wildlife & Chief Wildlife Warden, Assam, Panjabari, Guwahati-37 for favour of his kind information and necessary action.
2. The Chief Conservator of Forests & Nodal Officer (F.C. Act), Assam the Conservator of Forests, Lower Assam Social Forestry Circle, Bongaigaon for favour of his kind information.
3. The Conservator of Forests, Lower Assam Social Forestry Circle, Bongaigaon for favour of his kind information.

6/c

Habin
08/07/25
Divisional Forest Officer
Aie Valley Division
Bongaigaon

Norms for 20 ha Artificial Regeneration (AR) plantation with fruit bearing trees

Area (ha) = 20
 Spacing (m x m) = 2X2
 Wage Rate as per latest CAMPA norms = Rs 353
 Total quantity of saplings to be planted = 50,000 nos
 Total quantity of saplings to be raised/purchased = 82,500 nos

Sl no	Particulars of work	Units	Qty./Ha	Total Qty.	Rate/Unit	Amount (Rs.)
7	3RD YEAR MAINTENANCE					
	4 weeding, mulching and fire protection works @ 20 DLs/ha weeding	DLs	80	1600	353	5,64,800
	15% vacancy filling by 2 years old seedling from site nursery/CAMPA nursery	DLs	23	460	353	1,62,380
	Maintenance and protection of field nursery and 1 no. watch and ward for the plantation area for 365 days	DLs	1	365	353	1,28,845
	Maintenance of Camp Hut, implement, upkeep of plantation signboard, documentation, upkeep of records etc	LS				5000
	Contingency	LS				15,000
	Sub Total					8,76,025
8	4TH YEAR MAINTENANCE					
	4 weeding, mulching and fire protection works @ 15 DLs/ha/weeding	DLs	60	1200	353	5,64,800
	10% vacancy filling by 3 years old seedling from site nursery/CAMPA nursery	DLs	20	400	353	1,41,200
	Maintenance and protection of field nursery and 1 no. watch and ward for the plantation area for 365 days	DLs	1	365	353	1,28,845
	Maintenance of Camp Hut, implement, upkeep of plantation signboard, documentation, upkeep of records etc	LS				5000
	Contingency	LS				15,000
	Sub Total					8,54,845
9	5TH YEAR MAINTENANCE					
	3 weeding, climber cutting & other silvicultural works and fire protection works @ 15 DLs/ha	DLs	45	900	353	3,17,700
	Maintenance and protection of field nursery and 1 no. watch and ward for the plantation area for 365 days	DLs	1	365	353	1,28,845
	Maintenance of Camp Hut, implement, upkeep of plantation signboard, documentation, upkeep of records etc	LS				5000
	Contingency	LS				15,000
	Sub Total					4,66,545
	GRAND TOTAL					73,03,855





Approved by

 Conservator of Forests
 Lower Assam Social Forestry Circle
 Bongaigaon

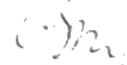
Countersigned by

 Divisional Forest Officer
 Ate Valley Division
 Bongaigaon

Submitted by

 Forest Range Officer
 Abhayapuri Range
 Abhayapuri

Bond		Indian-Non Judicial Stamp Haryana Government		Date : 18/03/2026	
Certificate No.	G0R2026C574		Stamp Duty Paid : ₹ 101		
GRN No.	148841143		Penalty : ₹ 0		
Deponent					
Name :	Nangal Bibra bongaigaon Transmission ltd				
H.No/Floor :	Na	Sector/Ward :	20	Landmark :	Tower b dlf cyber park
City/Village :	Gurugram	District :	Gurugram	State :	Haryana
Phone :	95*****48				
					
Purpose : FOR SUBMISSION OF COMPLIANCE to be submitted at Concerned office					

The authenticity of this document can be verified by scanning this QR Code Through smart phone or on the website <https://egrashry.nic.in>

Annexure-II

Undertaking for compliance with the conditions of the in-principle approval No. 3-AS B157/2023-GHY/3649-50, dated 28.02.2023, for the diversion of 61.6 ha of forest land for construction of 400 kV D/C Bongaigaon to Nangalbibra Transmission line under Haltugaon, Aie Valley, and Goalpara Forest divisions:

- 1) As per condition No. 2 A (15) of the IPA we, Nangalbibra-Bongaigaon Transmission Ltd. do hereby undertake that **“no violation of any of the conditions shall be done and accept that violation of any of these conditions will amount to violation of forest conservation Act, 1980.”**
- 2) As per condition No. 2 B (1) of the IPA we, Nangalbibra-Bongaigaon Transmission Ltd. do hereby undertake that **“Legal status of forest land proposed for diversion shall remain unchanged.”**
- 3) As per condition No. 2 B (3) of the IPA we, Nangalbibra-Bongaigaon Transmission Ltd. do hereby undertake that **“additional amount of NPV, if so determined, as per final decision of the hon’ble supreme court of India shall be paid by us”.**
- 4) As per condition No. 2 B (5) of the IPA we, Nangalbibra-Bongaigaon Transmission Ltd. do hereby undertake that, **“no labour camp shall be established on the forest land and fuels preferably the alternated fuel to labourers and the staff working at the**



site shall be provided so as to avoid any damage and pressure on the nearby forest areas.

- 5) As per condition No. 2 B (6) of the IPA we, Nangalbibra-Bongaigaon Transmission Ltd. do hereby undertake that **“the forest land proposed to be diverted shall under no circumstances be transferred to any other agencies, department or person without prior approval of Govt. of India”.**
- 6) As per condition No. 2 B (7) of the IPA we, Nangalbibra-Bongaigaon Transmission Ltd. do hereby undertake that **“no damage to the flora and fauna of the adjoining areas shall be caused.”**
- 7) As per condition No. 2 B (8) of the IPA we, Nangalbibra-Bongaigaon Transmission Ltd. do hereby undertake that **“layout of the proposal shall not be changed without the prior approval of the Central Government.”**
- 8) As per condition No. 2 B (11) of the IPA we, Nangalbibra-Bongaigaon Transmission Ltd. do hereby undertake that, **“compliance of all acts, rules, regulations, guidelines, the hon’ble court order(s) and NGT order(s) pertaining to this project, if any, for the time being in force as applicable to the project”.**
- 9) As per condition No. 2 B (12) of the IPA we, Nangalbibra-Bongaigaon Transmission Ltd. do hereby undertake **“to comply with the guidelines for laying transmission lines through forest areas issued by Ministry vide letter No- 7-25/2012/FC dated 05.05.2014 & 19/11/2014”.**
- 10) As per condition No. 2 B (13) of the IPA we, Nangalbibra-Bongaigaon Transmission Ltd. do hereby undertake that, **“no additional or new path will be constructed inside forest area for transportation of construction materials for execution of the project work”.**
- 11) As per condition No. 2 B (15) of the IPA we, Nangalbibra-Bongaigaon Transmission Ltd. do hereby undertake that, **“forest land shall not be used for any purpose other than that specified in the project proposal”.**

Date: 23/03/2026

Place: Aie Valley

Signature:



Name: Narottam Chakraborty

Designation: Head- Forest & Wildlife
Nangalbibra Bongaigaon Transmission Ltd.

Address of Agency:

Resonia Limited,
5th Floor, RMZ Infinity, Plot No 15
Phase IV, Sec-18, Gurugram, Haryana, 122015



GOVERNMENT OF ASSAM
OFFICE OF THE DEPUTY COMMISSIONER, BONGAIGAON
(ADMINISTRATION & MAGISTRACY BRANCH)

Phone No. 03664-230889

Email Id : dc-bongaigaon@nic.in



Form-I
(for linear projects)

To whomsoever it may concern

In compliance of the Ministry of Environment and Forest (MoEF) Government of India's letter No.11-9/98-FC(pt) dated 03/08/2009 wherein the MoEF issued guidelines on submission of evidences for having initiated and completed the process of settlement of rights under the Scheduled Tribes and other Traditional Forest Dwellers (Recognition of Forest Right) Act, 2006 ('FRA' for short) on the forest land proposed to be diverted for non-forest purposes read with MoEF's letter dated 6th February, 2013 wherein MoEF issued certain relaxation in respect of linear project, it is certified that 19.187 hectare of forest land proposed to be diverted in favour of Chief Manager, Sterlite Power, Gurugram, Haryana, Pin-122008 for construction of 400KV D/C Bongaigaon - Nangalbibra transmission line from Bongaigaon to Nangalbibra (purpose for diversion of forest land) in Bongaigaon district falls within jurisdiction of Bhairab pahar hill (location 173mtr to 884 mtr) under DFO, Aie Valley, Bongaigaon under Bongaigaon district.

It is further certified that:

- The complete process for identification and settlement of rights under the FRA has been carried out for the entire **19.187** hectare of forest area proposed for diversion. A copy of the letter received from DFO, Aie Valley Bongaigaon is enclosed as annexure.
- The diversion of forest land for facilities managed by the Government as required under section 3(2) of the FRA, does not arise as there is no locality or community found present in that area.
- The proposal does not involve recognized right of Primitive Tribal Groups and Pre-agricultural communities.

Encl: As stated

Date: 17/07/2023

Deputy Commissioner,
Bongaigaon

Deputy Commissioner
Bongaigaon

FORM-I

(for linear projects)
Government of Assam
Office of the Deputy Commissioner,
Goalpara

No. Rev/1487/2023-REV-GLP/71

Dated : 03rd June, 2023**TO WHOM SO EVER IT MAY CONCERN**

In compliance of the Ministry of Environment and Forests (MoEF), Government of India's letter No.11-9/98-FC(pt.) dated 3rd August, 2009, wherein the MoEF issued guidelines on submission of evidences for having initiated and completed the process of settlement of rights under the Scheduled Tribes and Other Traditional Forest Dwellers (Recognition of Forest Right) Act, 2006 ('FRA', for short) on the forest land proposed to be diverted for non-forest purposes read with MoEF's letter dated 5th February, 2013, wherein MoEF issued certain relaxation in respect of linear projects, it is certified that **41.747** hectares of forest land proposed to be diverted in favour of Sterlite Power for Construction of 400 KV D/C Bongaigaon-Nangalbibra Transmission Line in Goalpara district falls within jurisdiction of Pancharatna Hill RF, Bagulamari PRF, Sagunbahi RF, Rakhyasini PRF and Zangrajangsa RF under Balijana Tehsil.

It is further certified that:

- (a) The complete process for identification and settlement of rights under the FRA has been carried out for the entire.....hectares of forest area proposed for diversion. A copy of records of all consultations and meetings of the Forest Rights Committee (s), Gram Sabha (s), Sub-Division Level Committee (s) and the District Level Committee are enclosed as annexure.....to.....annexure.....(**Not Applicable**)
- (b) The diversion of forest land for facilities managed by the Government as required under section 3 (2) of the FRA have been completed and the Grama Sabhas have given their consent to it; (**Not Applicable**)
- (c) The proposal does not involve recognized right of Primitive Tribal Groups and Pre-agricultural communities.

**Signed by Khanindra
Choudhury**

Date: 03-06-2023 17:27:08

(Shri Khanindra Choudhury, IAS)
Deputy Commissioner,
Goalpara

FORM-1
(For linear project)

GOVERNMENT OF ASSAM
OFFICE OF THE DISTRICT MAGISTRATE, KOKRAJHAR
(MAGISTRACY BRANCH)

No.E-34035/102

Dated, Kokrajhar the 14th November' 2024.

TO WHOMSOEVER IT MAY CONCERN

In compliance of Ministry of Environment and Forest (MoEF), Government of India's No.11-9/98-FC(pt.) dated 3rd August' 2009 wherein the MoEF issued guidelines on submission of evidences for having initiated and completed the process of settlement of rights under the Schedule Tribes and Other Traditional Forest Dwellers (Recognition of Forest Rights) Act, 2006 (FRA, for short on the forest land proposed to be diverted for non-forest purposes read with MoEF's letter dated 5th February 2013 wherein MoEF issued certain relaxation in respect of linear project, it is certified that 0.666 Hectares of forest land proposed to be diverted in favour of Chief Manager, Nangalbibra-Bongaigaon Transmission Limited (name of user agency) for construction of 400KV D/C Bongaigaon Transmission Line (purpose for diversion of forest land) inKokrajhar district falls within jurisdiction of Satbhendi village (s) under No.2 Satbhendi RF under Nayekgaon Range under DFO, Haltugaon Division in Kokrajhar thehsils.

It is further certified that:

(a)The complete process for identification and settlement of rights under the FRA has been carried out for the entire 0.666 hectares of forest area proposed for diversion. A copy of records of all consultations and meetings/NOC of the forest Rights Committee, Gram Sabha, Sub-Division Level Committee, Bodoland Territorial Council (BTC) are enclosed as annexure 1 to V.

(b)The diversion of forest land for facilities managed by the Government as required under section 3(2) of the FRA have been completed and the Gram Sabha, SDLC and BTC have given their consent to it.

(c)The proposal does not involve recognized rights of Primitive Tribal groups and Pre agriculture communities.

Signed by
Masanda Magdalin Pertin
District Magistrate,
Kokrajhar
Date: 14/11/2024 17:21:00
District Magistrate
Kokrajhar

Forest Land Boundary Demarcation by Concrete Pillars



Three Layer Protection Measures implemented on Towers at Bhairab Forest to Restrict Climbing of Arboreal Animals

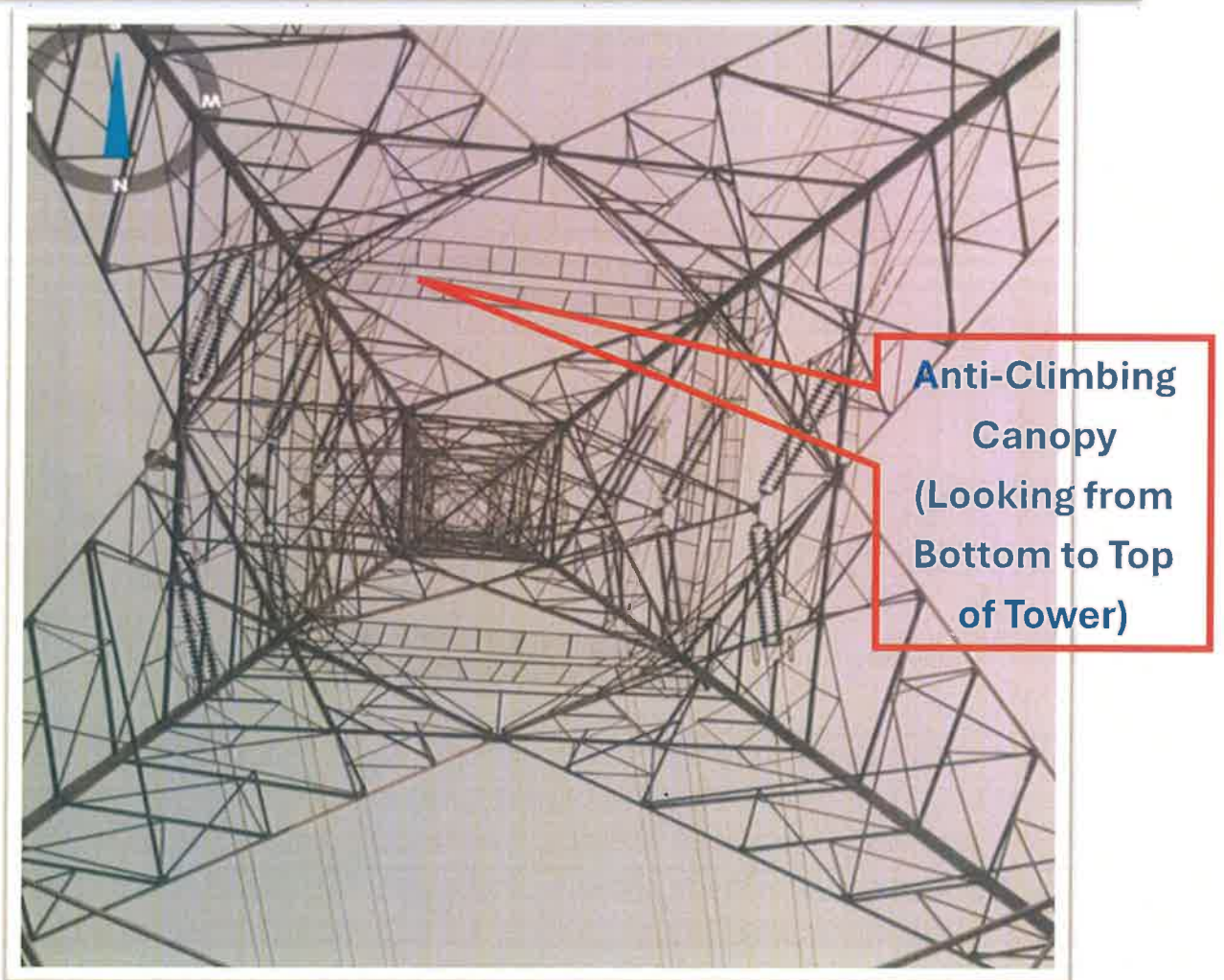
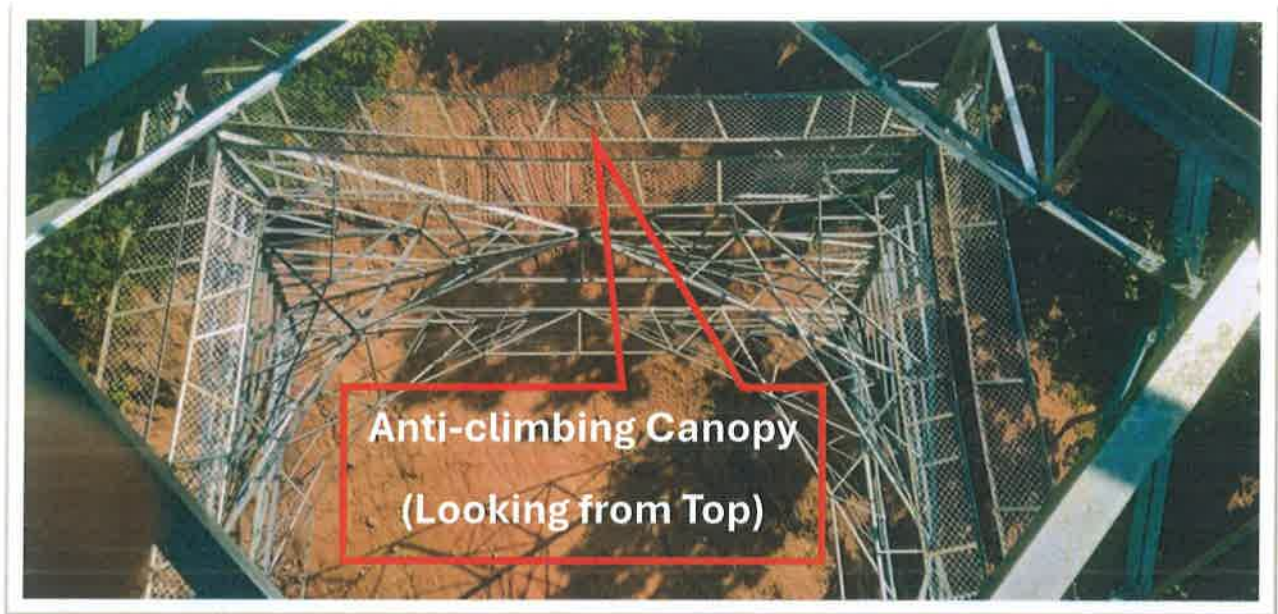

Three Layer Protection Measures implemented on Towers at Bhairab Forest to Restrict Climbing of Arboreal Animals

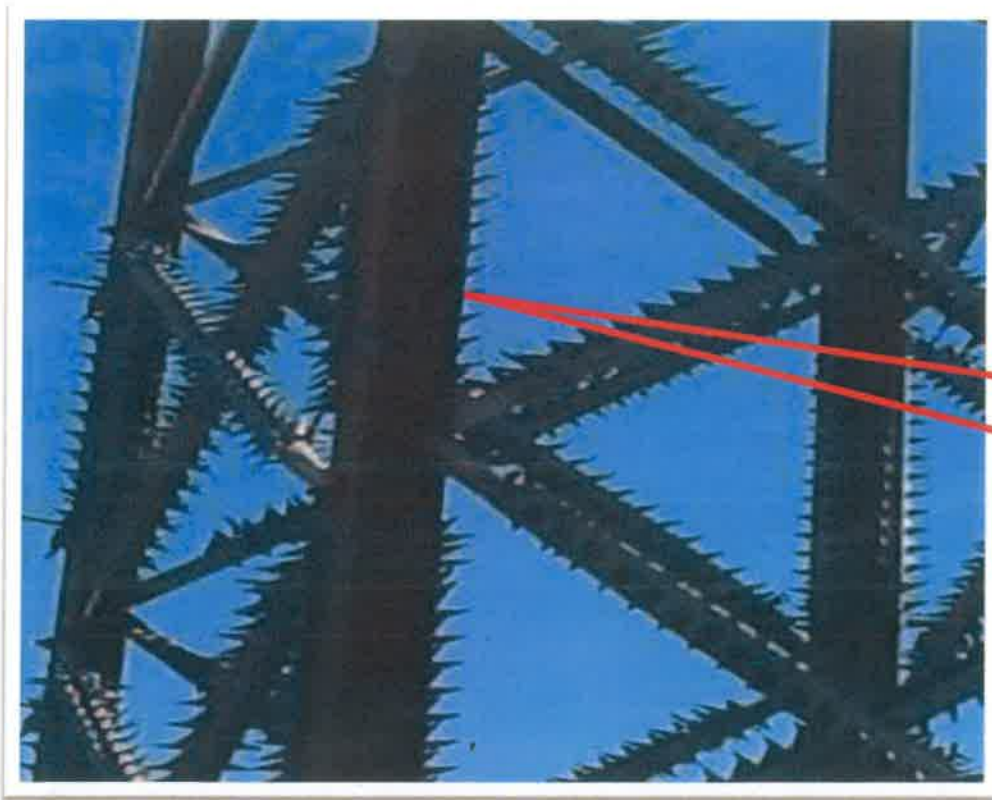

**Anti-Climbing
Guards**



**Anti-Climbing
Device with
Barbed wire
Fencing**

Bird Deflectors Installed on Upper Conductor of Transmission Line in Forest Land.



Sr. No	PART Description (BOM)	Description	QTY
A	UNIVERSAL CLAMP	High Grade Engineering Polymer	1
B	CONNECTING ROD	STAINLESS STEEL - corrosion free	1
C	HIGH TENSILE SPRING	STAINLESS STEEL - corrosion free	2
D	HOLDING SHAFT	STAINLESS STEEL - corrosion free	2
E	ROTATING MECHANISM	Self lubricating ball bearing with High Grade Engineering Polymer Case Cover	1
F	FLAPPER Ø195MM	High grade engineering Polymer	1

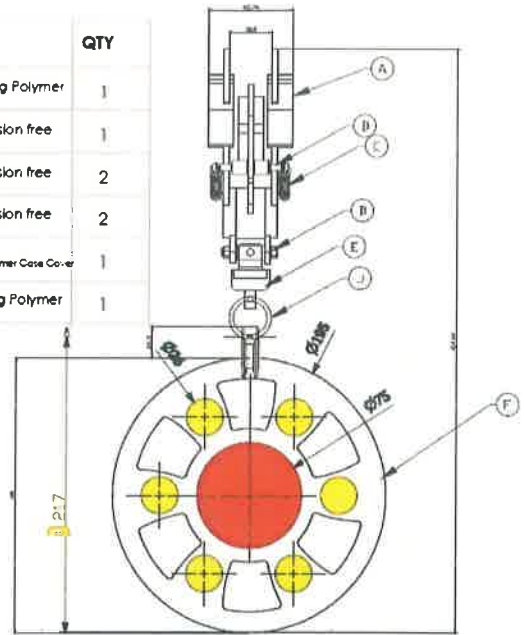

Bird Deflector installed on top conductor

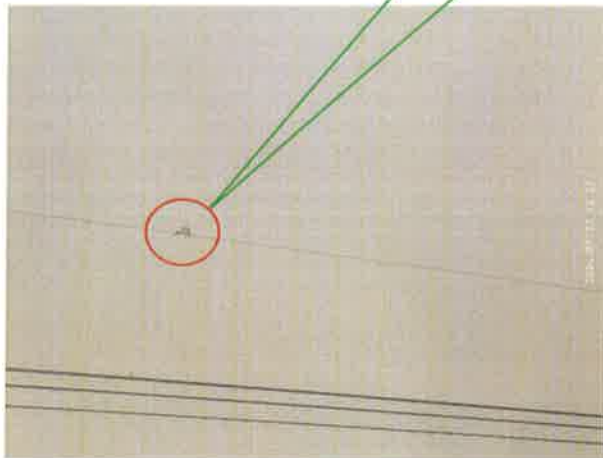

Bird Deflector installed on top conductor

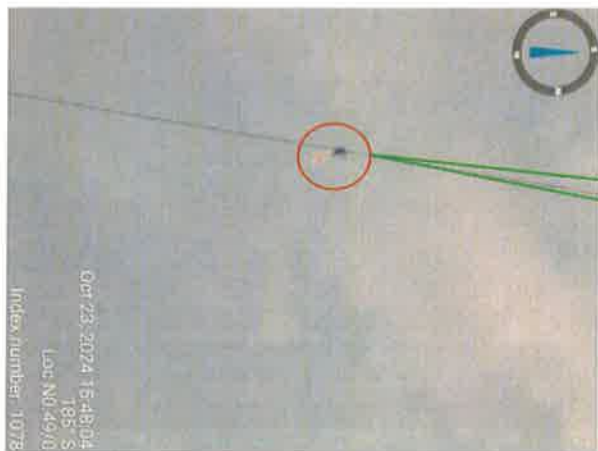

Date: 23-03-2026

To,
The Divisional Forest Officer
Haltugaon Forest Division
Kokrajhar, Assam.

Sub: Proposal for diversion of 61.6 ha (19.187 ha in Aie Valley Division, 41.747 in Goalpara Division, 0.666 ha in Haltugaon Division) forest area for construction of 400 kV D/C Bongaigaon-Nangalbibra Transmission line– ***submission of pointwise compliance report of the in-principle approval and request for processing the proposal for issuance of final approval.***

Ref:

1. In-Principle approval accorded by the MoEFCC, IRO Shillong vide F. No. 3-AS B 157/2023-GHY/3649-50, dated 28.02.2023.
2. Demand note raised by the DFO vide letter No. B/HFD/LD/NBTL/3653, dated 04.03.2023.
3. Demand letter of the PCCF Wildlife and Chief Wildlife Warden, Assam vide No. WL/FG/Proposal/Bongaigaon-Nangalbibra Trans line, dated 23.05.2025
4. Demand letter raised from the DFO, Aie Valley Division, Bongaigaon vide letter no. B/AVD/Sterlite/400kv/2025/3833, dated 08.07.2025.

Dear Sir,

With reference to the above, please find enclosed the revised pointwise compliance report of the In-Principle Approval accorded by the MoEFCC, IRO Shillong vide F. No. 3-AS B 157/2023-GHY/3649-50, dated 28th February 2023 along with necessary enclosures.

All the compensatory levies have been deposited to the Ad-hoc CAMPA Account and the given account of the DFO, Aie Valley which are tabulated below for ready reference.

Txn Posted Date	UTR No./Description	Payment head	TransactionAmount (INR)
10/04/2023	RTGS:ICICR52023041000 244493/UBIN0996335/AS SAMCAMP	NPV, CA, Overhead Cost and Medicinal Plantation in CAMPA through e-challan	59,09,539
27/04/2023	UTR No. ICICR52023052300636531 /HDFC0002016/DIVISION AL FOREST OFFICER	Erection of boundary pillars & departmental tree operation	10,10,000

NANGALBIBRA-BONGAIGAON TRANSMISSION LIMITED

DLF Cyber Park Tower-B, 9th Floor, Udyog Vihar Phase-III,
Sector-20, Gurugram-122008, Haryana India +91 0124 4562 000



13/03/2026	UTR No. HDFCR52026031381539908 CAMPA	Wildlife Conservation and Management Plan	1,10,13,814
20/03/2026	NEFT Ref No. NBTL200326R1 DFO, Aie Valley	Cost of Plantation of Fruits tree for Golden Langur	73,03,855
20/03/2026	NEFT Ref No. NBTL200326R1 DFO, Aie Valley	10 Nos JFMC for 5 years	4,65,25,000

In view of the above, you are requested to process the compliance report for issuance of the final approval from the competent authority.

Thanking You,
For **Nangalbibra-Bongaigaon Transmission Ltd**

(Authorized Signatory)



Narottam Chakraborty
Head- Forest & Wildlife

Copy to:

1. The Chief Conservator of Forests and the Nodal Officer (FC Act), Assam, Guwahati for kind information please.

Encl: Pointwise compliance report along with the enclosures.

COMPLIANCE REPORT

Pointwise compliance of the in-principle approval No. 3-AS B157/2023-GHY/3649-50, dated 28.02.2023 of the MoEF&CC, IRO Guwahati, for the diversion of 61.6 ha of forest land for construction of 400 kV D/C Bongaigaon to Nangalbibra Transmission line under Haltugaon, Aie Valley, and Goalpara Forest divisions.

A. Conditions need to be complied with prior handing over of forest- land by the State Forest Department:

Sl. No.	Conditions as per In-Principle approval vide F.No. 3-AS B 157/2023-GHY/3649-50	Compliance
1	<p>The User Agency shall transfer, the Net Present Value (NPV) of the forest land being diverted under this proposal as per the orders of the Hon'ble Supreme Court of India dated 28/03/2008, 24/04/2008 and 09/05/2008 in Writ petition (Civil) No. 202/1995 and as per guidelines issued by the Ministry vide letters No. 5-3/2007- FC, dated 05.02.2009 and File No. 5-3/2011FC(Vol-I), dated 21.03.2022. The requisite funds shall be transferred through online portal into CAMPA account of the State concerned.</p>	<p>Aie Valley Forest Division- The NPV amounting Rs. 8,61,039/- has been deposited in CAMPA account vide UTR No: ICICR52023041000244178 /UBIN099 6335/ASSAM CAMPA, dated 10.04.2023 reference to letter No. A/AVD /400KV/718-20, dated 13.03.2023 of the Divisional Forest Officer, Aie Valley forest division.</p> <p>Haltugaon Forest Division- The NPV amounting Rs. 2,75,65,387.30/- has been deposited in CAMPA account vide UTR No: ICICR52023041000244178/UBIN0996335/ASSAM CAMPA, dated 10.04.2023 reference to letter No. B/HFD/LD/NBTL/3653, dated 04.03.2023 of the Divisional Forest Officer, Haltugaon Forest Division</p> <p>Goalpara Forest Division- The NPV amounting Rs. 4,66,27,225/- has been deposited in CAMPA account vide UTR No: ICICR52023041000244178/UBIN0996335/ASSAM CAMPA, dated 10.04.2023 reference to letter No. B/GLP/ DFO(T) /FCA /Diversion proposal/Sterlite Power/1402, dated 13.03.2023 of the Divisional Forest Officer, Goalpara Forest Division.</p> <p>Online payment confirmation is enclosed as Annexure-I.</p>
2	<p>The User agency shall transfer the cost of raising and maintaining the Compensatory Afforestation at the current wage rate in consultation with State Forest Department in the account of CAMPA of the concern state through online portal. The Scheme may include appropriate provision for anticipated cost increase for work scheduled for subsequent years.</p>	<p>Aie Valley Forest Division- The cost of Compensatory Afforestation amounting Rs. 2,72,71,634.34/- has been deposited in CAMPA account vide UTR No: ICICR52023041000244178/UBIN0996335/ASSAM CAMPA, dated 10.04.2023 in reference to letter No. A/AVD/ 400KV/718-20, dated 13.03.2023 of the Divisional Forest Officer, Aie Valley forest division.</p> <p>Haltugaon Forest Division- The cost of Compensatory Afforestation amounting Rs. 33,94,500/- has been deposited in CAMPA account vide UTR No: ICICR52023041000244178/UBIN099633 5/ASSAM CAMPA, dated 10.04.2023 in reference to letter No. B/HFD/LD/NBTL/3653, dated 04.03.2023 of the Divisional Forest Officer, Haltugaon Forest Division.</p> <p>Goalpara Forest Division- The cost of Compensatory Afforestation amounting Rs. 6,55,60,057/- has been deposited in CAMPA account vide UTR No. ICICR52023041000244178/UBIN099633 5/ASSAMCAMP A, dated 10.04.2023 in reference to letter No.B/GLP/DFO(T) /FCA/Diversion Proposal/Sterlite Power/1402, dated 13.03.2023 of the Divisional Forest Officer, Goalpara Forest Division.</p> <p>Online payment confirmation is enclosed as Annexure-I.</p>



3	All the funds received from the user agency (CA and dwarf plantation cost, NPV etc.) under the project shall be transferred/deposited to compensatory Afforestation Fund of Assam State managed by the Ad-hoc CAMPA only through e-portal (https://parivesh.nic.in/). Amount deposited through other mode will not be accepted as compliance of Stage-I clearance.	The total amount of Rs. 191845839/- has been deposited in CAMPA account vide UTR No: ICICR52023041000244178/UBIN0996335/ASS AMCAMPA, dated 10.04.2023 in reference to the demand note of concerned Divisional Forest Officers, Assam. Online payment confirmation is enclosed as Annexure-I .
4	The KML files of the area to be diverted, the CA areas, the proposed SMC work, the proposed Catchment Area Treatment area and the WLMP area shall be uploaded on the e-Green watch portal with all requisite details before issuing working permission towards linear projects or submitting compliance report for seeking Stage-II approval, as the case may be.	Noted and shall be ensured.
5	The boundary of the diverted forest land shall be suitably demarcated on ground at the project cost, as per the direction of the concerned Divisional Forest Officer	<p>Aie Valley Forest Division- The boundary of the diverted forest land has been demarcated on ground at project cost by forest department. The amount of Rs. 7,69,850/- has been deposited in this regard at ICICI bank account no. 070805000767 as directed by the DFO, Aie Valley vide letter no. B/AVD/400KV/2156, dated 06/06/2023.</p> <p>Haltugaon Forest Division- The cost of Rs. 10,10,000/- for departmental operation of trees & boundary pillars, has been deposited, as directed by DFO, Haltugaon vide letter No.B/HFD/LD/NBTL/430, dated 07.05.2023.</p> <p>Goalpara Forest Division- The cost of Rs. 69,49,246/- for Departmental operation of trees & boundary pillars, has been deposited, as directed by DFO, Goalpara vide Letter No. B/GLP/DFO(T)/Diversion Proposal/Sterlite Power/2021, dated 17.04.2023.</p> <p>Photographs are enclosed as Appendix -I</p>
6	The user agency shall deposit 2% of the total project cost for Human Elephant Conflict mitigation and wildlife conservation purposes and the amount shall be deposited into account of CAMPA.	Reference to the demand letter of the PCCF Wildlife and Chief Wildlife Warden, Assam vide No. WL/FG/Proposal/Bongaigaon-Nangalbibra Trans line, dated 23.05.2025 the cost for Human Elephant Conflict mitigation and wildlife conservation purposes an amount of Rs.1,10,13,814/- (One Crore Ten Lakhs Thirteen Thousand Eight Hundred and Fourteen only) has been deposited in Ad-hoc CAMPA Account vide UTR No-HDFCR52026031381539908, dated 13.03.2026. The copy of above demand letter and payment details are enclosed as Annexure-I A .
7	The State Govt shall ensure that under no circumstances, implementation of such mitigation measures envisaged in Human Elephant/ Wildlife Conflict mitigation and wildlife conservation plan should be delayed beyond a period of 2 years to ensure commencement of rejuvenation of ecosystem services lost from the forest area allowed for non- forestry use of forest land at the earliest possible time	Noted.
8	The State Govt shall submit Human Elephant/wildlife Conflict mitigation and wildlife conservation plan approved by	As per demand letter received from the PCCF Wildlife and Chief Wildlife Warden, Assam vide No. WL/FG/Proposal/Bongaigaon-Nangalbibra Trans line, dated 23.05.2025 and demand letter of the

	Chief Wildlife Warden, Govt. of Assam along with detail cost of its implementation.	DFO, Aie Valley Division, dated 08.07.2025 amount of Rs. Rs.1,10,13,814/- has been deposited in Ad-hoc CAMPA Account vide UTR No- HDFCR52026031381539908, dated 13.03.2026 and Rs.5,38,28,855/- has been deposited to the bank account of the DFO, Aie Valley Division, through NEFT vide Ref No. NBTL200326R1 dated 20.03.2026.
9	<p>The State Govt. shall ensure to comply strictly to the following recommendation of the CWLW, Govt. of Assam: -</p> <p>a. Ground clearance shall be minimum of 15 m as proposed by the UA.</p> <p>b. Three-layer protection measures will be adopted to ensure complete safety and minimum interference with fauna. The measures include barbed fencing of tower area, Special tower design having soft material anti-climbing guards & anti-climbing canopy which will restrict any arboreal animals from climbing on towers.</p> <p>c. User Agency shall prepare and submit WL Management Plans suggested by Forest & WL Department.</p> <p>d. The User agency shall do plantation of fruit trees especially for Golden Langur in and around the Golden Langur habitat area through forest department.</p> <p>e. The user agency shall provide fund and support 10 Nos. of JFMCs for five years in and around Bhairab RF and other nearby forest which are habitat for Golden Langur for taking up Entry point Activity, livelihood activities, ecotourism facilities and capacity building for local youth.</p> <p>f. Felling of trees will be restored only at proposed tower locations and other areas shall be avoided.</p>	<p>All the mentioned conditions will be complied with.</p> <p>a. Ground clearance has been maintained minimum of 15 m along the route in Bhairab RF.</p> <p>b. Three-layer protection measures have been adopted at all the towers in Bhairab RF. Photographs enclosed as Appendix II.</p> <p>c. Reference to the demand letter of the PCCF Wildlife and Chief Wildlife Warden, Assam vide No. WL/FG/Proposal/Bongaigaon-Nangalbibra Trans line, dated 23.05.2025 the cost for Human Elephant Conflict mitigation and wildlife conservation purposes an amount of Rs.1,10,13,814/- (One Crore Ten Lakhs Thirteen Thousand Eight Hundred and Fourteen only) has been deposited in Ad-hoc CAMPA Account vide UTR No-HDFCR52026031381539908, dated 13.03.2026. The copy of above demand letter and payment details are enclosed as Annexure-I A.</p> <p>d. The cost of plantation of fruit trees especially for Golden Langur in and around the Golden Langur habitat area amounting to Rs. 73,03,855/- (Rs. Seventy Three Lakhs Three Thousand and Eight Hundred and Fifty Five only) has been deposited to the bank account of the DFO, Aie Valley Division, Bongaigaon through NEFT vide Ref No. NBTL200326R1, dated 20.03.2026 against demand letter raised from the DFO, Aie Valley Division, Bongaigaon, dated 08.07.2025. The copy of above demand letter and payment details are enclosed as Annexure -I A.</p> <p>e. The cost of supporting 10 Nos of JFMCs for five years in and around Bhairab RF and other nearby forest amounting to Rs. 4,65,25,000/- (Rs. Four Crore Sixty-Five Lakhs and Twenty Five Thousand only) has been deposited to the bank account of the DFO, Aie Valley Division, Bongaigaon through NEFT vide Ref No. NBTL200326R1, dated 20.03.2026 against demand letter raised from the DFO, Aie Valley Division, Bongaigaon, dated 08.07.2025. The copy of above demand letter and payment details are enclosed as Annexure -I A.</p> <p>f. Felling of trees have been restricted at the tower locations and bare minimum in the corridor to maintain safe electrical clearance as per Indian standard.</p>
10	The user agency shall explore the possibility of successful translocation of maximum number of trees identified to be felled shall be explored and any tree felling shall be done only when it is unavoidable and that too under strict supervision of the State Forest department.	Translocation of trees have been explored, and unavoidable trees were only felled by the forest department.

11	The charges for felling, logging and transportation of project affected trees should be collected from the User Agency at the rates approved by the State Govt and deposited with the DFO concerned for utilization immediately following the diversion of forest land.	<p>Aie Valley Forest Division- The cost of Departmental operation of trees has been deposited in the ICICI bank account no. 070805000767 as directed by the DFO, Aie Valley vide letter No. B/AVD/400KV/2156, dated 06/06/2023.</p> <p>Haltugaon Forest Division- The cost of Rs. 10,10,000/- for departmental operation of trees & boundary pillars, has been deposited, as directed by the DFO, Haltugaon vide letter No.B/HFD/LD/NBTL/430, dated 07.05.2023.</p> <p>Goalpara Forest Division- The cost of Rs. 69,49,246/- for Departmental operation of trees & boundary pillars, has been deposited, as directed by the DFO, Goalpara vide letter No. B/GLP/DFO(T)/Diversion Proposal/Sterlite Power/2021, dated 17.04.2023.</p>
12	The expenditure like boundary walls, stone pillars, demarcation charges, cost of damage of trees the funds on these accounts should be deposited with the DFO concerned.	<p>Aie Valley Forest Division- The cost of boundary pillars and Departmental operation of trees has been deposited in the ICICI bank account no. 070805000767 as directed by the DFO, Aie Valley vide Letter No. B/AVD/400KV/2156, dated 06.06.23 & B/AVD/400KV/BNG to Nagalbibra/2024/3364, dated 08.08.24.</p> <p>Haltugaon Forest Division- The cost of Rs. 10,10,000/- for departmental operation of trees & boundary pillars, has been deposited, as directed by the DFO, Haltugaon vide letter No.B/HFD/LD/NBTL/430, dated 07.05.2023.</p> <p>Goalpara Forest Division- The cost of Rs. 69,49,246/- for Departmental operation of trees & boundary pillars, has been deposited, as directed by the DFO, Goalpara vide letter No. B/GLP/DFO(T)/Diversion Proposal/Sterlite Power/2021, dated 17.04.2023.</p>
13	The User Agency shall restrict the felling of trees to minimum number in the diverted forest land and the trees will be felled under the strict supervision of the State Forest Department, and the cost of felling of trees has been deposited to the state Forest Department.	Unavoidable trees were only felled by Forest Department & cost of felling has been deposited as per demand of all the concerned DFO.
14	The complete compliance of the FRA, 2006 shall be ensured by way of prescribed certificate from the concerned District Collector.	The complete compliance of the FRA, 2006 have been completed in all three districts. FRA certificates enclosed as Annexure-III .
15	Violation of any of these conditions will amount to violation of Forest (conservation) Act, 1980 and action would be taken as prescribed in para 1.21 of chapter 1 of the Handbook of comprehensive guidelines of Forest (conservation) Act, 1980 as issued by this Ministry's letter No. 5-2/2017-Fc dated 28.03.2019.	Agreed. Undertaking in this regard is enclosed as Annexure-II .
16	The User Agency in consultation with the State Forest Department prepare a detailed scheme for creation and maintenance of plantation of dwarf species (preferably medicinal plants) in right of way under the transmission line for execution of the said scheme to the State Forest Department.	Aie Valley Forest Division- The detailed scheme for creation and maintenance of plantation of dwarf species in right of way under the transmission line has been prepared. The cost of Dwarf Plantation Rs. 48,22,821/- has been deposited in CAMPA account vide UTR No: ICICR52023041000244178/UBIN099633/ASSAM CAMPA, dated 10.04.2023 in reference to letter No. A/AVD/400KV/718-20, dated 13.03.2023 of the Divisional Forest Officer, Aie Valley forest division.

		<p>Haltugaon Forest Division- The detailed scheme for creation and maintenance of plantation of dwarf species in right of way under the transmission line has been prepared. The cost for Dwarf Plantation Rs. 16,54,000/- has been deposited in CAMPA account vide UTR No: ICICR52023041000244178/UBIN0996335/ASSAM CAMPA, dated 10.04.2023 in reference to letter No. B/HFD/LD/NBTL/3653, dated 04.03.2023 of the Divisional Forest Officer, Haltugaon Forest Division.</p> <p>Goalpara Forest Division- The detailed scheme for creation and maintenance of plantation of dwarf species in right of way under the transmission line has been prepared. The cost for Dwarf Plantation Rs. 1,40,89,175/- has been deposited in CAMPA account vide UTR No: ICICR52023041000244178/UBIN099633/ASSAM CAMPA, dated 10.04.2023 in reference to letter No.B/GLP/DFO(T)/FCA/Diversion Proposal/ Sterlite Power/1402, dated 13.03.2023 of the Divisional Forest Officer, Goalpara Forest Division.</p> <p>Online payment confirmation enclosed as Annexure-I.</p>
17	The compliance report shall be uploaded on -e-portal (https://parivesh.nic.in)	Noted and shall be complied.

B. Conditions need to be strictly complied on field after handing over of forest- land to the user agency by the State Forest Department but the compliance in form of undertaking shall be submitted prior to Stage-II approval:

Sl. No.	Conditions as per In- Principle approval vide F.No. 3-AS B 157/2023-GHY/3649-50	Compliance
1	Legal status of forest land proposed for diversion shall remain unchanged.	Agreed. Undertaking in this regard is enclosed as Annexure-II .
2	The compensatory Afforestation shall be taken up on doubled the degraded forest land of 125.35 ha which has been identified in three different patches i.e. 1.35 ha in Nayekgaon Range, Haltugaon Forest Division in Kokrajhar district; 84 ha in Lakhipur Range in Nalbari RF (10 ha), Central Range, Krishnai, Zengrazanga (39 ha), Central Krishnai Zengrazanga (25 ha), Rongjuli Dolngdo Reserve Forest (10 ha) in Goalpara District; and 40 ha in Abhayapuri Range, Aie vally Forest Division in Bongaigaon District of Assam within three years from the date of Stage-II clearance and maintained thereafter by the State Forest Department at the cost of the User Agency. As far as possible, a mixture of local indigenous species shall be planted, and monoculture of any species may be avoided. The CA will be maintained for 10 years.	Cost for raising Compensatory Afforestation for all the locations in three Forest Divisions has been deposited in CAMPA account vide UTR No: ICICR52023041000244178/UBIN0996335/ASSAM CAMPA, dated 10.04.2023. Online payment confirmation enclosed as Annexure-I
3	At the time of payment of the Net Present Value (NPV) at the time of prevailing rate, the User Agency shall furnish an undertaking to pay the additional amount of NPV, if so determined, as per final decision of the Hon'ble Supreme Court of India	Agreed. Undertaking in this regard is enclosed as Annexure-II .
4	The User Agency shall obtain the Environment Clearance as per the provisions of Environment (Protection) Act, 1986, if required (NA).	Not applicable for transmission line projects.
5	No labour camp shall be established on the forest land and fuels preferably the alternated fuel to labourers and the staff working at the site shall be provided so as to avoid any damage and pressure on the nearby forest areas.	Agreed. Undertaking in this regard is enclosed as Annexure-II .
6	The forest land proposed to be diverted shall under no circumstances be transferred to any other agencies.	Agreed. Undertaking in this regard is enclosed as Annexure-II .

	department, or person without prior approval of the Govt. of India.	
7	No damage to the flora and fauna of the adjoining areas shall be caused.	Shall be complied. Undertaking in this regard is enclosed as Annexure-II .
8	The layout of the proposal shall not be changed without prior approval of the central Govt.	Agreed. Undertaking in this regard is enclosed as Annexure-II .
9	The concerned Divisional Forest Officer will monitor and take necessary mitigative measures to ensure that there is no adverse impact on the forests in the surrounding Area.	Noted.
10	The User Agency at its cost shall provide bird deflectors which are to be fixed on the upper conductor of transmission line at suitable interval to avoid bird hits.	The bird deflectors have been installed on the upper conductor of transmission line at suitable interval. Photographs enclosed as Appendix III .
11	The User Agency shall comply all the provision of all Acts, Rules, Regulations, Guidelines, Hon'ble Court Order(s) and NGT Order(s) pertaining to this project, if any, for the time being in force as applicable to the project	Agreed. Undertaking in this regard is enclosed as Annexure-II .
12	The User Agency shall comply with the guidelines for laying transmission through forest areas issued by Ministry vide letter No. 7-25/2012-FC, dated 5/05/2014 & 19/11/2014.	Agreed. Undertaking in this regard is enclosed as Annexure-II .
13	No additional or new path will be constructed inside the forest area for transportation of construction materials for execution of the project work.	Agreed. Undertaking in this regard is enclosed as Annexure-II .
14	The period of diversion under this approval shall be co-terminus with the period of lease to be granted in favour of the user agency or the project life, whichever is less.	Agreed.
15	The forest land shall not be used for any purpose other than that specified in the project proposal.	Agreed. Undertaking in this regard is enclosed as Annexure-II .
16	As per Ministry's letter no 11-30/96-FC (Pt) dt. 14.9.2001 if the compliance of stipulated conditions is awaited from the State Govt for more than 5 (five) years, the in-principle approval would be summarily revoked considering that the user agency is no longer interested in the project.	Agreed.
17	Any other conditions that the Integrated Regional Office, Guwahati, MoEFCC may be stipulated from time to time in the interest of conservation protection and development of Forest & Wildlife	Agreed.

Date: 23/03/2026

Signature:



Name: Narottam Chakraborty

Designation: Head- Forest & Wildlife

Nagalbibra-Bongaigaon Transmission Ltd.

Address of Agency:

Resonia Limited,

5th Floor, RMZ Infinity, Plot No 15

Phase IV, Sec-18, Gurugram, Haryana, 122015.



PARIVESH

 परितर

"Pro Active and Responsive facilitation by Interactive, Virtuous and Environmental Singlwindow Hub"

Ministry of Environment, Forest and Climate Change

 Government of India



- [Home](#)
- [My Account](#)
- [My Proposals Environment Clearance](#)
- [Only CRZ Clearance](#)
- [My Proposals Forest Clearance](#)
- [My Proposals Wildlife Clearance](#)
- [Help](#)

3:07:26 PM

Online payment history made by User Agency under CAHPA

Help

Sno.	Proposal Detail	Application_No	Application No (New)	Date of TR-PRINCIPLE	Amount to be Paid/Amount Paid (in Rs.)	Payment Status	Payment Detail	Demand Letter
1	EP/AS/TRANS/152968/2022 Construction of 400 KV DC Bongaijain Nangalobra Transmission Line	TRANS152968202296894152968966		28 Feb 2023	CA: 96226192/- PCA: 0/- Safety Zone: 0/- NPV: 75053651/- Other Charges1: 0/- Other Charges2: 0/- Other Charges3: 0/- Total: 191645839/-	 Paid	Fund Demand Verified by : 15 Mar 2023 Nodal Officer On : Bank Name : Union Bank Of India Mode of Payment : NIFT/RTGS (Challan) Challan Generated On : 25 Mar 2023 Transaction Date : 11 Apr 2023	Demand Letter Generated Challan



 Digital India



 data.gov.in



 india.gov.in



 myGov



 MeitY



 NIFT



NANGALBIBRA-BONGAIGAON TRANSMISSION LIMITED

DLF Cyber Park Tower-B, 9th Floor, Udyog Vihar Phase-III,
Sector-20, Gurugram-122008, Haryana India +91 0124 4562 000



ANNEXURE- I A

PAYMENT DETAILS

Date	UTR No	Payment Description	Payment Head	Transaction Amount
13/03/2026	UTR No. HDFCR52026031381539908	Wildlife Conservation and Management Plan	CAMPA Assam A/C No. 150617299	1,10,13,814
20/03/2026	NEFT Ref No. NBTL200326R1	Cost of Plantation of Fruits tree for Golden Langur	A/C No. 070805000767	73,03,855
20/03/2026	NEFT Ref No. NBTL200326R1	10 Nos JFMC for 5 years	A/C No. 070805000767	4,65,25,000



(Authorized Signatory)

Narottam Chakraborty
Head- Forest & Wildlife
Nangalbibra Bongaigaon Transmission Ltd.



GOVERNMENT OF ASSAM
OFFICE OF THE PRINCIPAL CHIEF CONSERVATOR OF FORESTS, WILDLIFE AND
CHIEF WILDLIFE WARDEN, ASSAM

Email ID: pccf.wl.assam@gmail.com

No. WL/FG/Proposal/Bongaigaon-Nangalbibra Trans line

Date: **23**.05.2025

To,

The Chief Manger,
Nangalbibra-Bongaigaon Transmission Ltd.,
2nd Floor, Samriddhi Complex, New Market,
Pancharatna Road, Goalpara, Assam-783101.

Sub: Deposition of 2% project cost for Human Elephant/Wildlife Conflict Mitigation & Wildlife Conservation purpose against proposal for “diversion of 61.6 Ha. of forest land for construction of 400 kV D/C Bongaigaon to Nangalbira Transmission Line in Sathbandi RF, Bhairab RF, Pancharatna RF, Sagunbari RF, Zangrazangsa RF, Bogulmari PRF & Rakshashini PRF under haltugaon Division (area-0.66 Ha), Aie Valley Division (area-19.187 Ha) & Goalpara Division (41.747 Ha) by Nangalbibra-Bongaigaon Transmission Ltd”.

Ref: 1. This office letter No. WL/FG/proposal/Bongaigaon-Nangalbibra Trans line, dated 07.06.2023.
2. Your office letter No. NBTL/FOREST/2025-26/01, dated 30.04.2025.

Sir,

Pursuant to the MoEF & CC, Govt of India's F.No. 3 AS B 157/2023-GHY/3649-50, dated 20.02.2023 granting “In Principle Approval/Stage-I” for the above-mentioned proposal and with reference to the subject and letters cited above, it is requested to deposit 2% of the proportionate project cost to the account of CAMPA, as estimated below:

- (a) Total area of the project both in the state of Assam & Meghalaya = 563.772 Ha.
- (b) Total area of project in the state of Meghalaya (non-forest + forest) = 243.496 Ha.
- (c) Total area of the project in the state of Assam (non-forest + forest) = 320.276 Ha.
- (d) Area of forest land proposed for diversion in the state of Assam = 61.6 Ha.
- (e) Proportionate cost of the project in the state of Assam = $320.276/563.772 \times \text{Rs } 504,00,00,000 = \text{Rs } 286,31,98,314/-$
- (f) **2% proportionate project cost** = $61.6/320.276 \times \text{Rs. } 286,31,98,314 \times 2\%$
= Rs 1,10,13,814/-

In view of the above, it is requested to deposit an above-mentioned amount of **Rs 1,10,13,814/- (one crore ten lakhs thirteen thousand eight hundred fourteen only)** for preparation and implementation of Human Elephant/Wildlife Conflict Mitigation & Wildlife Conservation and Management Plan with special emphasis on Golden Langur, in the account of CAMPA.

This is for your kind information and necessary action.

Yours faithfully,



(Dr. Vinay Gupta, IFS)
Principal Chief Conservator of Forests,
Wildlife & Chief Wildlife Warden, Assam.

Copy for information and necessary action to.

1. CCF & Nodal Officer (FC Act), Assam, O/o the PCCF & HoFF, Assam. This has a reference to this office letter No. WL/FG/Proposal/Bongaigaon-Nangalbibra Trans line, dated 26.12.2024 and your letter No. FG.27/FCA/Proposal/Nangalbibra-Bongaigaon Transmission Ltd., dated 18.02.2025.
2. DFO, Goalpara Division, Goalpara, Aie Valley Division, Bongaigaon & Haltugaon Division, Kokrajhar.



Principal Chief Conservator of Forests,
Wildlife & Chief Wildlife Warden, Assam.

Copy for information to Principal Chief Conservator of Forests & Head of Forest Force, Assam, Panjabari, Guwahati-37.



Principal Chief Conservator of Forests,
Wildlife & Chief Wildlife Warden, Assam.



GOVT.OF ASSAM
OFFICE OF THE DIVISIONAL FOREST OFFICER:::AIE VALLEY DIVISION
BONGAIGAON.

E-mail- dfo.t.aievalley@gmail.com

No. B/AVD/Sterlite/400kv/2025/ 3833
To,

Date: 08/07/25

The Chief Manager
Sterlite Power Transmission Limited
2nd Floor, Samriddhi Complex
New Market, Pancharatna Road
Goalpara, Assam-783101

Sub: Demand note for submission of Human Elephant/Wildlife Conflict Mitigation and Wildlife Conservation Plan against the project "Construction of 400 KV DC Nangalbibra-Bongaigaon Transmission Line.

Ref: MoEF & CC Regional Office, Guwahati vide F.No.3 AS B 157/2023 GHY/3649-50,
dt. 28.02.2023 &
Your letter No. NBTL/FOREST/2025-26/02, dtd. 06.05.2025

Sir,

With reference to the subject cited above, you are requested to deposit the cost of plantation of fruit bearing species for Golden Langur & fund for 10(ten) nos. J.F.M.C. for implementing different activities within five years around the Bhairab Hill R.F. as per condition no. A.(9)(d) &(e) of the "In Principle Approval/Stage-I" clearance accorded by the Central Government vide Regional Office, Shillong, Ministry of Environment, Forest & Climate Change letter no. F.No. 3 AS B 157/2023 GHY/3649-50, dt. 28.02.2023 against the project "Construction of 400 KV DC Nangalbibra-Bongaigaon Transmission Line. The amount should be deposited in the following Bank Account and the details break up of amount shown below.

- | | | |
|------|---|--------------------------|
| (i) | Cost of raising plantation for fruit bearing species for Golden Langur | Rs. 73,03,855/- |
| (ii) | Cost of 10(ten) nos. J.F.M.C. for different schemes for five years around the Bhairab Hill R.F. | Rs. 4,65,25,000/- |
| | Total= | Rs. 5,38,28,855/- |

In words: (Rupees Five Crore Thirty Eight Lakh Twenty Eight Thousand Eight hundred Fifty Five) only

Bank Details:

Name of A/C holder : Divisional Forest Officer,
Aie Valley Division, Bongaigaon
Name of Bank : ICICI Bank, Bongaigaon Branch
Account No. : 70805000767
IFSC : ICIC0000708

This is for your kind information and necessary action.

Yours faithfully

Habin
08/07/25
Divisional Forest Officer
Aie Valley Division
Bongaigaon

Date: 08/07/25

No. A/AVD/Sterlite/400kv/2025/ 3583-85
Copy to:

1. The Principal Chief Conservator of Forests, Wildlife & Chief Wildlife Warden, Assam, Panjabari, Guwahati-37 for favour of his kind information and necessary action.
2. The Chief Conservator of Forests & Nodal Officer (F.C. Act), Assam the Conservator of Forests, Lower Assam Social Forestry Circle, Bongaigaon for favour of his kind information.
3. The Conservator of Forests, Lower Assam Social Forestry Circle, Bongaigaon for favour of his kind information.

6/c

Habin
08/07/25
Divisional Forest Officer
Aie Valley Division
Bongaigaon

Norms for 20 ha Artificial Regeneration (AR) plantation with fruit bearing trees

Area (ha) = 20
 Spacing (m x m) = 2X2
 Wage Rate as per latest CAMPA norms = Rs 353
 Total quantity of saplings to be planted = 50,000 nos
 Total quantity of saplings to be raised/purchased = 82,500 nos

Sl no	Particulars of work	Units	Qty./Ha	Total Qty.	Rate/Unit	Amount (Rs.)
7	3RD YEAR MAINTENANCE					
	4 weeding, mulching and fire protection works @ 20 DLs/ha weeding	DLs	80	1600	353	5,64,800
	15% vacancy filling by 2 years old seedling from site nursery/CAMPA nursery	DLs	23	460	353	1,62,380
	Maintenance and protection of field nursery and 1 no. watch and ward for the plantation area for 365 days	DLs	1	365	353	1,28,845
	Maintenance of Camp Hut, implement, upkeep of plantation signboard, documentation, upkeep of records etc	LS				5000
	Contingency	LS				15,000
	Sub Total					8,76,025
8	4TH YEAR MAINTENANCE					
	4 weeding, mulching and fire protection works @ 15 DLs/ha/weeding	DLs	60	1200	353	5,64,800
	10% vacancy filling by 3 years old seedling from site nursery/CAMPA nursery	DLs	20	400	353	1,41,200
	Maintenance and protection of field nursery and 1 no. watch and ward for the plantation area for 365 days	DLs	1	365	353	1,28,845
	Maintenance of Camp Hut, implement, upkeep of plantation signboard, documentation, upkeep of records etc	LS				5000
	Contingency	LS				15,000
	Sub Total					8,54,845
9	5TH YEAR MAINTENANCE					
	3 weeding, climber cutting & other silvicultural works and fire protection works @ 15 DLs/ha	DLs	45	900	353	3,17,700
	Maintenance and protection of field nursery and 1 no. watch and ward for the plantation area for 365 days	DLs	1	365	353	1,28,845
	Maintenance of Camp Hut, implement, upkeep of plantation signboard, documentation, upkeep of records etc	LS				5000
	Contingency	LS				15,000
	Sub Total					4,66,545
	GRAND TOTAL					73,03,855

Approved by

 Conservator of Forests
 Lower Assam Social Forestry Circle
 Bongaigaon

Countersigned by

 Divisional Forest Officer
 Ate Valley Division
 Bongaigaon

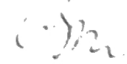
Submitted by

 Forest Range Officer
 Abhayapuri Range
 Abhayapuri

Bond		Indian-Non Judicial Stamp Haryana Government		Date : 18/03/2026
Certificate No.	G0R2026C574		Stamp Duty Paid : ₹ 101	
GRN No.	148841143		Penalty : ₹ 0	
Deponent				
Name :	Nangal Bibra bongaigaon Transmission ltd			
H.No/Floor :	Na	Sector/Ward : 20	Landmark : Tower b dlf cyber park	
City/Village :	Gurugram	District : Gurugram	State : Haryana	
Phone :	95*****48			
				
Purpose : FOR SUBMISSION OF COMPLIANCE to be submitted at Concerned office				

The authenticity of this document can be verified by scanning this QrCode Through smart phone or on the website <https://egrashry.nic.in>

Annexure-II

Undertaking for compliance with the conditions of the in-principle approval No. 3-AS B157/2023-GHY/3649-50, dated 28.02.2023, for the diversion of 61.6 ha of forest land for construction of 400 kV D/C Bongaigaon to Nangalbibra Transmission line under Haltugaon, Aie Valley, and Goalpara Forest divisions:

- 1) As per condition No. 2 A (15) of the IPA we, Nangalbibra-Bongaigaon Transmission Ltd. do hereby undertake that **“no violation of any of the conditions shall be done and accept that violation of any of these conditions will amount to violation of forest conservation Act, 1980.”**
- 2) As per condition No. 2 B (1) of the IPA we, Nangalbibra-Bongaigaon Transmission Ltd. do hereby undertake that **“Legal status of forest land proposed for diversion shall remain unchanged.”**
- 3) As per condition No. 2 B (3) of the IPA we, Nangalbibra-Bongaigaon Transmission Ltd. do hereby undertake that **“additional amount of NPV, if so determined, as per final decision of the hon’ble supreme court of India shall be paid by us”.**
- 4) As per condition No. 2 B (5) of the IPA we, Nangalbibra-Bongaigaon Transmission Ltd. do hereby undertake that, **“no labour camp shall be established on the forest land and fuels preferably the alternated fuel to labourers and the staff working at the site shall be provided so as to avoid any damage and pressure on the nearby forest areas.**
- 5) As per condition No. 2 B (6) of the IPA we, Nangalbibra-Bongaigaon Transmission Ltd. do hereby undertake that **“the forest land proposed to be diverted shall under no**



Anty

circumstances be transferred to any other agencies, department or person without prior approval of Govt. of India” .

- 6) As per condition No. 2 B (7) of the IPA we, Nangalbibra-Bongaigaon Transmission Ltd. do hereby undertake that **“no damage to the flora and fauna of the adjoining areas shall be caused.”**
- 7) As per condition No. 2 B (8) of the IPA we, Nangalbibra-Bongaigaon Transmission Ltd. do hereby undertake that **“layout of the proposal shall not be changed without the prior approval of the Central Government.”**
- 8) As per condition No. 2 B (11) of the IPA we, Nangalbibra-Bongaigaon Transmission Ltd. do hereby undertake that, **“compliance of all acts, rules, regulations, guidelines, the hon’ble court order(s) and NGT order(s) pertaining to this project, if any, for the time being in force as applicable to the project” .**
- 9) As per condition No. 2 B (12) of the IPA we, Nangalbibra-Bongaigaon Transmission Ltd. do hereby undertake **“to comply with the guidelines for laying transmission lines through forest areas issued by Ministry vide letter No- 7-25/2012/FC dated 05.05.2014 & 19/11/2014” .**
- 10) As per condition No. 2 B (13) of the IPA we, Nangalbibra-Bongaigaon Transmission Ltd. do hereby undertake that, **“no additional or new path will be constructed inside forest area for transportation of construction materials for execution of the project work” .**
- 11) As per condition No. 2 B (15) of the IPA we, Nangalbibra-Bongaigaon Transmission Ltd. do hereby undertake that, **“forest land shall not be used for any purpose other than that specified in the project proposal” .**

Date: 23/03/2026

Place: Haltugaon

Signature:



Name: Narottam Chakraborty

Designation: Head- Forest & Wildlife

Nangalbibra-Bongaigaon Transmission Ltd.

Address of Agency:

Resonia Limited,

5th Floor, RMZ Infinity, Plot No 15

Phase IV, Sec-18, Gurugram, Haryana, 122015

FORM-1
(For linear project)

GOVERNMENT OF ASSAM
OFFICE OF THE DISTRICT MAGISTRATE, KOKRAJHAR
(MAGISTRACY BRANCH)

No.E-34035/102

Dated, Kokrajhar the 14th November' 2024.

TO WHOMSOEVER IT MAY CONCERN

In compliance of Ministry of Environment and Forest (MoEF), Government of India's No.11-9/98-FC(pt.) dated 3rd August' 2009 wherein the MoEF issued guidelines on submission of evidences for having initiated and completed the process of settlement of rights under the Schedule Tribes and Other Traditional Forest Dwellers (Recognition of Forest Rights) Act, 2006 (FRA, for short on the forest land proposed to be diverted for non-forest purposes read with MoEF's letter dated 5th February 2013 wherein MoEF issued certain relaxation in respect of linear project, it is certified that 0.666 Hectares of forest land proposed to be diverted in favour of Chief Manager, Nangalbibra-Bongaigaon Transmission Limited (name of user agency) for construction of 400KV D/C Bongaigaon Transmission Line (purpose for diversion of forest land) inKokrajhar district falls within jurisdiction of Satbhendi village (s) under No.2 Satbhendi RF under Nayekgaon Range under DFO, Haltugaon Division in Kokrajhar thehsils.

It is further certified that:

(a)The complete process for identification and settlement of rights under the FRA has been carried out for the entire 0.666 hectares of forest area proposed for diversion. A copy of records of all consultations and meetings/NOC of the forest Rights Committee, Gram Sabha, Sub-Division Level Committee, Bodoland Territorial Council (BTC) are enclosed as annexure 1 to V.

(b)The diversion of forest land for facilities managed by the Government as required under section 3(2) of the FRA have been completed and the Gram Sabha, SDLC and BTC have given their consent to it.

(c)The proposal does not involve recognized rights of Primitive Tribal groups and Pre agriculture communities.

Signed by
Masanda Magdalin Pertin
District Magistrate,
Kokrajhar
Date: 14/11/2024 17:21:00
District Magistrate
Kokrajhar

Forest Land Boundary Demarcation by Concrete Pillars



Three Layer Protection Measures implemented on Towers at Bhairab Forest to Restrict Climbing of Arboreal Animals

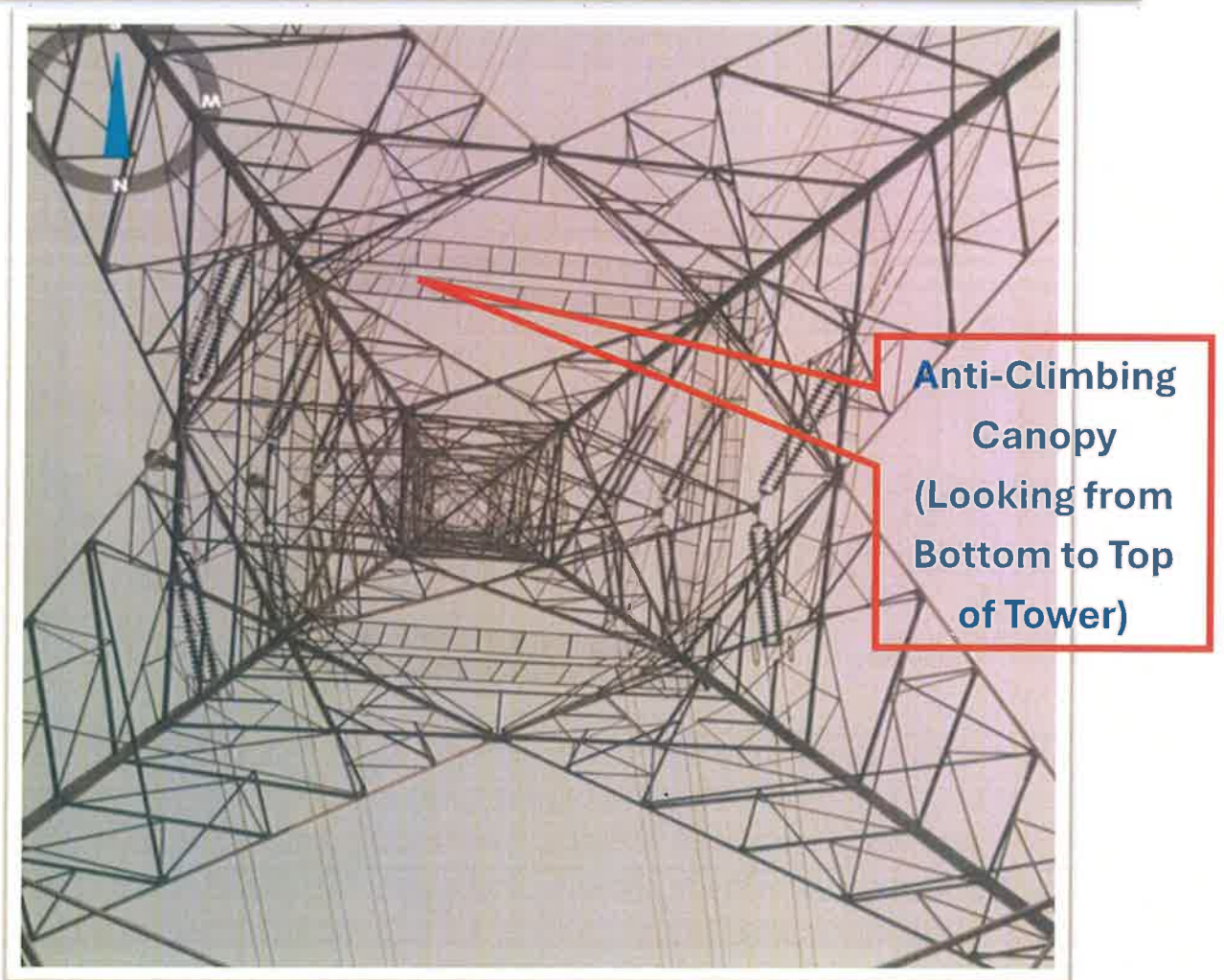
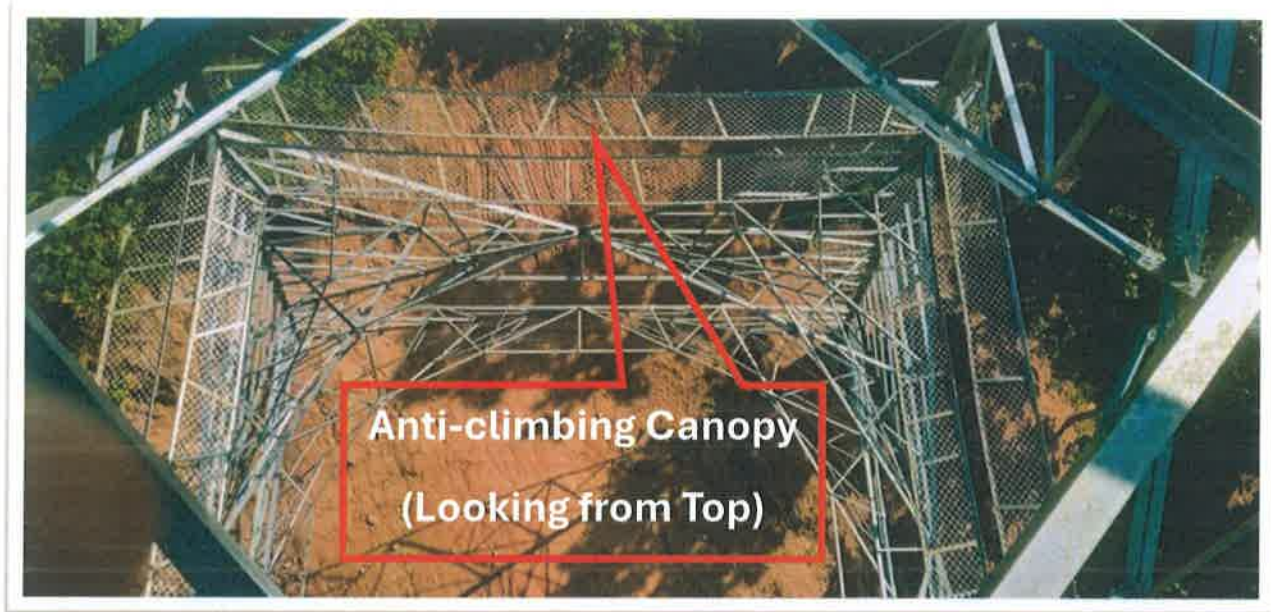

Three Layer Protection Measures implemented on Towers at Bhairab Forest to Restrict Climbing of Arboreal Animals

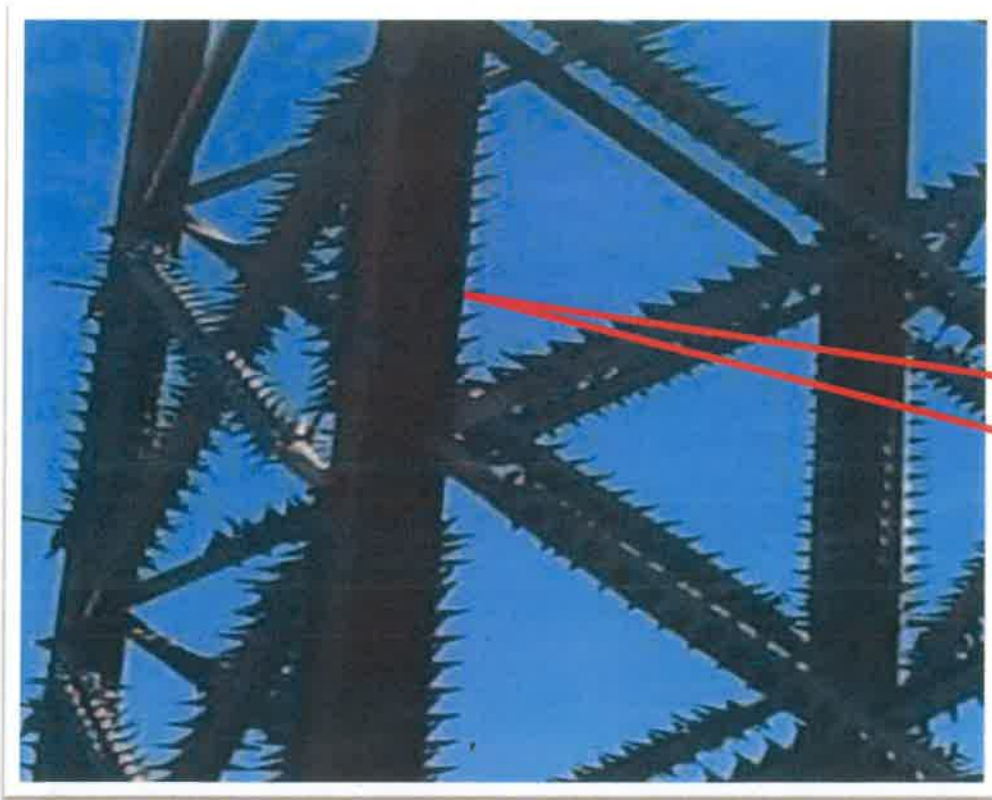

**Anti-Climbing
Guards**



**Anti-Climbing
Device with
Barbed wire
Fencing**

Bird Deflectors Installed on Upper Conductor of Transmission Line in Forest Land.

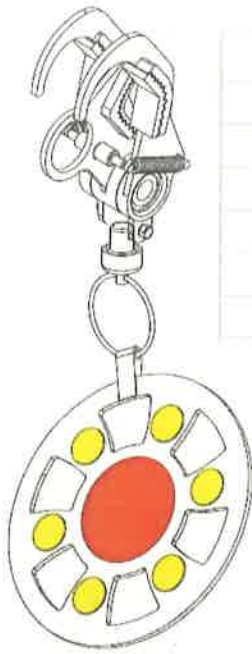

Sr. No	PART Description (BOM)	Description	QTY
A	UNIVERSAL CLAMP	High Grade Engineering Polymer	1
B	CONNECTING ROD	STAINLESS STEEL - corrosion free	1
C	HIGH TENSILE SPRING	STAINLESS STEEL - corrosion free	2
D	HOLDING SHAFT	STAINLESS STEEL - corrosion free	2
E	ROTATING MECHANISM	Self lubricating ball bearing with High Grade Engineering Polymer Case Cover	1
F	FLAPPER Ø195MM	High grade engineering Polymer	1

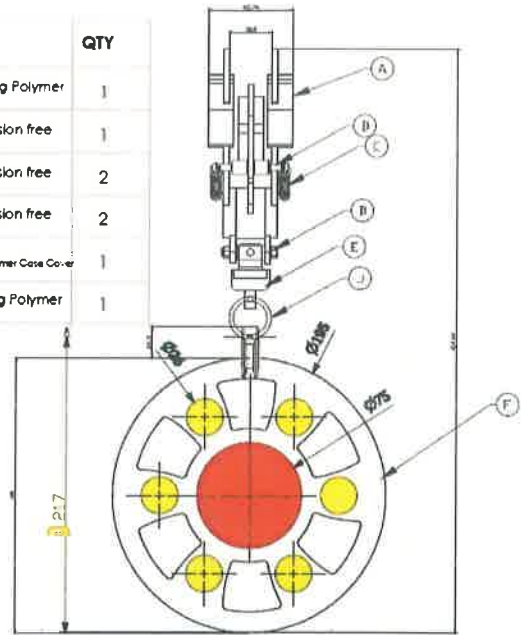

Bird Deflector installed on top conductor

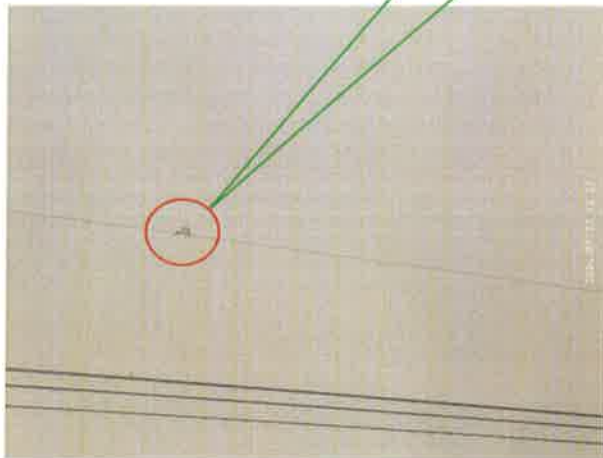

Bird Deflector installed on top conductor

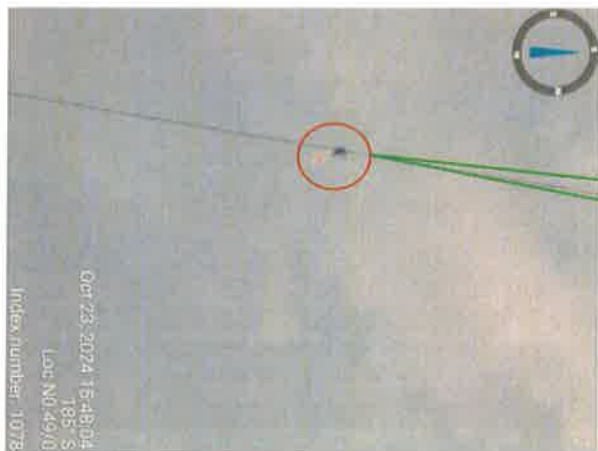

Date: 23-03-2026

To,

The Divisional Forest Officer,

Goalpara Forest Division,

Goalpara, Assam

Sub: Proposal for diversion of 61.6 ha (19.187 ha in Aie Valley Division, 41.747 in Goalpara Division, 0.666 ha in Haltugaon Division) forest area for construction of 400 kV D/C Bongaigaon-Nangalbibra Transmission line– ***submission of pointwise compliance report of the in-principle approval and request for processing the proposal for issuance of final approval.***

Ref:

1. In-Principle approval accorded by the MoEFCC, IRO Shillong vide F. No. 3 -AS B 157/2023 -GHY/3649-50, dated 28.02.2023.
2. Demand note raised by the DFO vide letter No. B/GLP/DFO(T)/FCA/Diversion Proposal/Sterlite Power/1402, dated 13.03.2023.
3. Demand letter of the PCCF Wildlife and Chief Wildlife Warden, Assam vide No. WL/FG/Proposal/Bongaigaon-Nangalbibra Trans line, dated 23.05.2025
4. Demand letter raised from the DFO, Aie Valley Division, Bongaigaon vide letter no. B/AVD/Sterlite/400kv/2025/3833, dated 08.07.2025.

Dear Sir,

With reference to the above, please find enclosed the revised pointwise compliance report of the In-Principle approval accorded by the MoEFCC, IRO Shillong vide F. No. 3-AS B 157/2023GHY/3649-50, dated 28th February 2023 along with necessary enclosures.

All the compensatory levies have been deposited to the Ad-hoc CAMPA Account and the given account of the DFO, Aie Valley which are tabulated below for ready reference.

Txn Posted Date	UTR No./ Description	Payment head	Transaction Amount (INR)
10/04/2023	RTGS: ICICR52023041000244886/ UBIN0996335/ASSAMCAMP	NPV, CA, Overhead Cost and Medicinal Plantation in CAMPA through e-challan	12,62,76,457
27/04/2023	UTR No. ICICR52023052300638561/SBIN00000 82/DIVISIONAL FOREST OFFICER	Erection of boundary pillars	6,61,196
27/04/2023	UTR No. ICICR52023052300638561/SBIN0000 082/DIVISIONAL FOREST OFFICER	Departmental operation	14,57,700

NANGALBIBRA-BONGAIGAON TRANSMISSION LIMITED

DLF Cyber Park Tower-B, 9th Floor, Udyog Vihar Phase-III,
Sector-20, Gurugram-122008, Haryana India +91 0124 4562 000



27/04/2023	UTR No. ICICR52023052300638561/SBIN0000 082/DIVISIONAL FOREST OFFICER	Maintenance timber depot and security Camp	23,90,800
27/04/2023	UTR No. ICICR52023052300638561/SBIN0000 082/DIVISIONAL FOREST OFFICER	Hiring good quality Mahindra vehicles	24,34,550
04/04/2024	UTR No. ICICR52024040400571353/SBIN0000 082/DIVISIONAL FOREST OFFICER	Departmental operation	42,56,220
13/03/2026	UTR No. HDFCR52026031381539908 CAMPA	Wildlife Conservation and Management Plan	1,10,13,814
20/03/2026	NEFT Ref No. NBTL200326R1 DFO, Aie Valley	Cost of Plantation of Fruits tree for Golden Langur	73,03,855
20/03/2026	NEFT Ref No. NBTL200326R1 DFO, Aie Valley	10 Nos JFMC for 5 years	4,65,25,000

In view of the above, you are requested to process the compliance report for issuance of the final approval from the competent authority.

Thanking You,

Nangalbibra-Bongaigaon Transmission Ltd



(Authorized Signatory)
Narottam Chakraborty
Head- Forest & Wildlife

Copy to:

1. The Chief Conservator of Forests and the Nodal Officer (FC Act), Assam, Guwahati for kind information please.

Encl: Pointwise compliance report along with the enclosures.

COMPLIANCE REPORT

Pointwise compliance of the in-principle approval No. 3-AS B157/2023-GHY/3649-50, dated 28.02.2023 of the MoEF&CC, IRO Guwahati, for the diversion of 61.6 ha of forest land for construction of 400 kV D/C Bongaigaon to Nangalbibra Transmission line under Haltugaon, Aie Valley, and Goalpara Forest divisions.

A. Conditions need to be complied with prior handing over of forest- land by the State Forest Department:

Sl. No.	Conditions as per In-Principle approval vide F.No. 3-AS B 157/2023-GHY/3649-50	Compliance
1	<p>The User Agency shall transfer, the Net Present Value (NPV) of the forest land being diverted under this proposal as per the orders of the Hon'ble Supreme Court of India dated 28/03/2008, 24/04/2008 and 09/05/2008 in Writ petition (Civil) No. 202/1995 and as per guidelines issued by the Ministry vide letters No. 5-3/2007- FC, dated 05.02.2009 and File No. 5-3/2011FC(Vol-I), dated 21.03.2022. The requisite funds shall be transferred through online portal into CAMPA account of the State concerned.</p>	<p>Aie Valley Forest Division- The NPV amounting Rs. 8,61,039/- has been deposited in CAMPA account vide UTR No: ICICR52023041000244178 /UBIN099 6335/ASSAM CAMPA, dated 10.04.2023 reference to letter No. A/AVD /400KV/718-20, dated 13.03.2023 of the Divisional Forest Officer, Aie Valley forest division.</p> <p>Haltugaon Forest Division- The NPV amounting Rs. 2,75,65,387.30/- has been deposited in CAMPA account vide UTR No: ICICR52023041000244178/UBIN0996335/ASSAM CAMPA, dated 10.04.2023 reference to letter No. B/HFD/LD/NBTL/3653, dated 04.03.2023 of the Divisional Forest Officer, Haltugaon Forest Division</p> <p>Goalpara Forest Division- The NPV amounting Rs. 4,66,27,225/- has been deposited in CAMPA account vide UTR No: ICICR52023041000244178/UBIN0996335/ASSAM CAMPA, dated 10.04.2023 reference to letter No. B/GLP/ DFO(T) /FCA /Diversion proposal/Sterlite Power/1402, dated 13.03.2023 of the Divisional Forest Officer, Goalpara Forest Division.</p> <p>Online payment confirmation is enclosed as Annexure-I.</p>
2	<p>The User agency shall transfer the cost of raising and maintaining the Compensatory Afforestation at the current wage rate in consultation with State Forest Department in the account of CAMPA of the concern state through online portal. The Scheme may include appropriate provision for anticipated cost increase for work scheduled for subsequent years.</p>	<p>Aie Valley Forest Division- The cost of Compensatory Afforestation amounting Rs. 2,72,71,634.34/- has been deposited in CAMPA account vide UTR No: ICICR52023041000244178/UBIN0996335/ASSAM CAMPA, dated 10.04.2023 in reference to letter No. A/AVD/ 400KV/718-20, dated 13.03.2023 of the Divisional Forest Officer, Aie Valley forest division.</p> <p>Haltugaon Forest Division- The cost of Compensatory Afforestation amounting Rs. 33,94,500/- has been deposited in CAMPA account vide UTR No: ICICR52023041000244178/UBIN099633 5/ASSAM CAMPA, dated 10.04.2023 in reference to letter No. B/HFD/LD/NBTL/3653, dated 04.03.2023 of the Divisional Forest Officer, Haltugaon Forest Division.</p> <p>Goalpara Forest Division- The cost of Compensatory Afforestation amounting Rs. 6,55,60,057/- has been deposited in CAMPA account vide UTR No. ICICR52023041000244178/UBIN099633 5/ASSAMCAMP A, dated 10.04.2023 in reference to letter No.B/GLP/DFO(T) /FCA/Diversion Proposal/Sterlite Power/1402, dated 13.03.2023 of the Divisional Forest Officer, Goalpara Forest Division.</p> <p>Online payment confirmation is enclosed as Annexure-I.</p>



3	All the funds received from the user agency (CA and dwarf plantation cost, NPV etc.) under the project shall be transferred/deposited to compensatory Afforestation Fund of Assam State managed by the Ad-hoc CAMPA only through e-portal (https://parivesh.nic.in/). Amount deposited through other mode will not be accepted as compliance of Stage-I clearance.	The total amount of Rs. 191845839/- has been deposited in CAMPA account vide UTR No: ICICR52023041000244178/UBIN0996335/ASS AMCAMPA, dated 10.04.2023 in reference to the demand note of concerned Divisional Forest Officers, Assam. Online payment confirmation is enclosed as Annexure-I .
4	The KML files of the area to be diverted, the CA areas, the proposed SMC work, the proposed Catchment Area Treatment area and the WLMP area shall be uploaded on the e-Green watch portal with all requisite details before issuing working permission towards linear projects or submitting compliance report for seeking Stage-II approval, as the case may be.	Noted and shall be ensured.
5	The boundary of the diverted forest land shall be suitably demarcated on ground at the project cost, as per the direction of the concerned Divisional Forest Officer	<p>Aie Valley Forest Division- The boundary of the diverted forest land has been demarcated on ground at project cost by forest department. The amount of Rs. 7,69,850/- has been deposited in this regard at ICICI bank account no. 070805000767 as directed by the DFO, Aie Valley vide letter no. B/AVD/400KV/2156, dated 06/06/2023.</p> <p>Haltugaon Forest Division- The cost of Rs. 10,10,000/- for departmental operation of trees & boundary pillars, has been deposited, as directed by DFO, Haltugaon vide letter No.B/HFD/LD/NBTL/430, dated 07.05.2023.</p> <p>Goalpara Forest Division- The cost of Rs. 69,49,246/- for Departmental operation of trees & boundary pillars, has been deposited, as directed by DFO, Goalpara vide Letter No. B/GLP/DFO(T)/Diversion Proposal/Sterlite Power/2021, dated 17.04.2023.</p> <p>Photographs are enclosed as Appendix -I</p>
6	The user agency shall deposit 2% of the total project cost for Human Elephant Conflict mitigation and wildlife conservation purposes and the amount shall be deposited into account of CAMPA.	Reference to the demand letter of the PCCF Wildlife and Chief Wildlife Warden, Assam vide No. WL/FG/Proposal/Bongaigaon-Nangalbibra Trans line, dated 23.05.2025 the cost for Human Elephant Conflict mitigation and wildlife conservation purposes an amount of Rs.1,10,13,814/- (One Crore Ten Lakhs Thirteen Thousand Eight Hundred and Fourteen only) has been deposited in Ad-hoc CAMPA Account vide UTR No-HDFCR52026031381539908, dated 13.03.2026. The copy of above demand letter and payment details are enclosed as Annexure-I A .
7	The State Govt shall ensure that under no circumstances, implementation of such mitigation measures envisaged in Human Elephant/ Wildlife Conflict mitigation and wildlife conservation plan should be delayed beyond a period of 2 years to ensure commencement of rejuvenation of ecosystem services lost from the forest area allowed for non- forestry use of forest land at the earliest possible time	Noted.
8	The State Govt shall submit Human Elephant/wildlife Conflict mitigation and wildlife conservation plan approved by	As per demand letter received from the PCCF Wildlife and Chief Wildlife Warden, Assam vide No. WL/FG/Proposal/Bongaigaon-Nangalbibra Trans line, dated 23.05.2025 and demand letter of the

	Chief Wildlife Warden, Govt. of Assam along with detail cost of its implementation.	DFO, Aie Valley Division, dated 08.07.2025 amount of Rs. Rs.1,10,13,814/- has been deposited in Ad-hoc CAMPA Account vide UTR No- HDFCR52026031381539908, dated 13.03.2026 and Rs.5,38,28,855/- has been deposited to the bank account of the DFO, Aie Valley Division, through NEFT vide Ref No. NBTL200326R1 dated 20.03.2026.
9	<p>The State Govt. shall ensure to comply strictly to the following recommendation of the CWLW, Govt. of Assam: -</p> <p>a. Ground clearance shall be minimum of 15 m as proposed by the UA.</p> <p>b. Three-layer protection measures will be adopted to ensure complete safety and minimum interference with fauna. The measures include barbed fencing of tower area, Special tower design having soft material anti-climbing guards & anti-climbing canopy which will restrict any arboreal animals from climbing on towers.</p> <p>c. User Agency shall prepare and submit WL Management Plans suggested by Forest & WL Department.</p> <p>d. The User agency shall do plantation of fruit trees especially for Golden Langur in and around the Golden Langur habitat area through forest department.</p> <p>e. The user agency shall provide fund and support 10 Nos. of JFMCs for five years in and around Bhairab RF and other nearby forest which are habitat for Golden Langur for taking up Entry point Activity, livelihood activities, ecotourism facilities and capacity building for local youth.</p> <p>f. Felling of trees will be restored only at proposed tower locations and other areas shall be avoided.</p>	<p>All the mentioned conditions will be complied with.</p> <p>a. Ground clearance has been maintained minimum of 15 m along the route in Bhairab RF.</p> <p>b. Three-layer protection measures have been adopted at all the towers in Bhairab RF. Photographs enclosed as Appendix II.</p> <p>c. Reference to the demand letter of the PCCF Wildlife and Chief Wildlife Warden, Assam vide No. WL/FG/Proposal/Bongaigaon-Nangalbibra Trans line, dated 23.05.2025 the cost for Human Elephant Conflict mitigation and wildlife conservation purposes an amount of Rs.1,10,13,814/- (One Crore Ten Lakhs Thirteen Thousand Eight Hundred and Fourteen only) has been deposited in Ad-hoc CAMPA Account vide UTR No-HDFCR52026031381539908, dated 13.03.2026. The copy of above demand letter and payment details are enclosed as Annexure-I A.</p> <p>d. The cost of plantation of fruit trees especially for Golden Langur in and around the Golden Langur habitat area amounting to Rs. 73,03,855/- (Rs. Seventy Three Lakhs Three Thousand and Eight Hundred and Fifty Five only) has been deposited to the bank account of the DFO, Aie Valley Division, Bongaigaon through NEFT vide Ref No. NBTL200326R1, dated 20.03.2026 against demand letter raised from the DFO, Aie Valley Division, Bongaigaon, dated 08.07.2025. The copy of above demand letter and payment details are enclosed as Annexure -I A.</p> <p>e. The cost of supporting 10 Nos of JFMCs for five years in and around Bhairab RF and other nearby forest amounting to Rs. 4,65,25,000/- (Rs. Four Crore Sixty-Five Lakhs and Twenty Five Thousand only) has been deposited to the bank account of the DFO, Aie Valley Division, Bongaigaon through NEFT vide Ref No. NBTL200326R1, dated 20.03.2026 against demand letter raised from the DFO, Aie Valley Division, Bongaigaon, dated 08.07.2025. The copy of above demand letter and payment details are enclosed as Annexure -I A.</p> <p>f. Felling of trees have been restricted at the tower locations and bare minimum in the corridor to maintain safe electrical clearance as per Indian standard.</p>
10	The user agency shall explore the possibility of successful translocation of maximum number of trees identified to be felled shall be explored and any tree felling shall be done only when it is unavoidable and that too under strict supervision of the State Forest department.	Translocation of trees have been explored, and unavoidable trees were only felled by the forest department.

11	The charges for felling, logging and transportation of project affected trees should be collected from the User Agency at the rates approved by the State Govt and deposited with the DFO concerned for utilization immediately following the diversion of forest land.	<p>Aie Valley Forest Division- The cost of Departmental operation of trees has been deposited in the ICICI bank account no. 070805000767 as directed by the DFO, Aie Valley vide letter No. B/AVD/400KV/2156, dated 06/06/2023.</p> <p>Haltugaon Forest Division- The cost of Rs. 10,10,000/- for departmental operation of trees & boundary pillars, has been deposited, as directed by the DFO, Haltugaon vide letter No.B/HFD/LD/NBTL/430, dated 07.05.2023.</p> <p>Goalpara Forest Division- The cost of Rs. 69,49,246/- for Departmental operation of trees & boundary pillars, has been deposited, as directed by the DFO, Goalpara vide letter No. B/GLP/DFO(T)/Diversion Proposal/Sterlite Power/2021, dated 17.04.2023.</p>
12	The expenditure like boundary walls, stone pillars, demarcation charges, cost of damage of trees the funds on these accounts should be deposited with the DFO concerned.	<p>Aie Valley Forest Division- The cost of boundary pillars and Departmental operation of trees has been deposited in the ICICI bank account no. 070805000767 as directed by the DFO, Aie Valley vide Letter No. B/AVD/400KV/2156, dated 06.06.23 & B/AVD/400KV/BNG to Nagalbibra/2024/3364, dated 08.08.24.</p> <p>Haltugaon Forest Division- The cost of Rs. 10,10,000/- for departmental operation of trees & boundary pillars, has been deposited, as directed by the DFO, Haltugaon vide letter No.B/HFD/LD/NBTL/430, dated 07.05.2023.</p> <p>Goalpara Forest Division- The cost of Rs. 69,49,246/- for Departmental operation of trees & boundary pillars, has been deposited, as directed by the DFO, Goalpara vide letter No. B/GLP/DFO(T)/Diversion Proposal/Sterlite Power/2021, dated 17.04.2023.</p>
13	The User Agency shall restrict the felling of trees to minimum number in the diverted forest land and the trees will be felled under the strict supervision of the State Forest Department, and the cost of felling of trees has been deposited to the state Forest Department.	Unavoidable trees were only felled by Forest Department & cost of felling has been deposited as per demand of all the concerned DFO.
14	The complete compliance of the FRA, 2006 shall be ensured by way of prescribed certificate from the concerned District Collector.	The complete compliance of the FRA, 2006 have been completed in all three districts. FRA certificates enclosed as Annexure-III .
15	Violation of any of these conditions will amount to violation of Forest (conservation) Act, 1980 and action would be taken as prescribed in para 1.21 of chapter 1 of the Handbook of comprehensive guidelines of Forest (conservation) Act, 1980 as issued by this Ministry's letter No. 5-2/2017-Fc dated 28.03.2019.	Agreed. Undertaking in this regard is enclosed as Annexure-II .
16	The User Agency in consultation with the State Forest Department prepare a detailed scheme for creation and maintenance of plantation of dwarf species (preferably medicinal plants) in right of way under the transmission line for execution of the said scheme to the State Forest Department.	Aie Valley Forest Division- The detailed scheme for creation and maintenance of plantation of dwarf species in right of way under the transmission line has been prepared. The cost of Dwarf Plantation Rs. 48,22,821/- has been deposited in CAMPA account vide UTR No: ICICR52023041000244178/UBIN099633/ASSAM CAMPA, dated 10.04.2023 in reference to letter No. A/AVD/400KV/718-20, dated 13.03.2023 of the Divisional Forest Officer, Aie Valley forest division.

		<p>Haltugaon Forest Division- The detailed scheme for creation and maintenance of plantation of dwarf species in right of way under the transmission line has been prepared. The cost for Dwarf Plantation Rs. 16,54,000/- has been deposited in CAMPA account vide UTR No: ICICR52023041000244178/UBIN0996335/ASSAM CAMPA, dated 10.04.2023 in reference to letter No. B/HFD/LD/NBTL/3653, dated 04.03.2023 of the Divisional Forest Officer, Haltugaon Forest Division.</p> <p>Goalpara Forest Division- The detailed scheme for creation and maintenance of plantation of dwarf species in right of way under the transmission line has been prepared. The cost for Dwarf Plantation Rs. 1,40,89,175/- has been deposited in CAMPA account vide UTR No: ICICR52023041000244178/UBIN099633/ASSAM CAMPA, dated 10.04.2023 in reference to letter No.B/GLP/DFO(T)/FCA/Diversion Proposal/ Sterlite Power/1402, dated 13.03.2023 of the Divisional Forest Officer, Goalpara Forest Division.</p> <p>Online payment confirmation enclosed as Annexure-I.</p>
17	The compliance report shall be uploaded on -e-portal (https://parivesh.nic.in)	Noted and shall be complied.

B. Conditions need to be strictly complied on field after handing over of forest- land to the user agency by the State Forest Department but the compliance in form of undertaking shall be submitted prior to Stage-II approval:

Sl. No.	Conditions as per In- Principle approval vide F.No. 3-AS B 157/2023-GHY/3649-50	Compliance
1	Legal status of forest land proposed for diversion shall remain unchanged.	Agreed. Undertaking in this regard is enclosed as Annexure-II .
2	The compensatory Afforestation shall be taken up on doubled the degraded forest land of 125.35 ha which has been identified in three different patches i.e. 1.35 ha in Nayekgaon Range, Haltugaon Forest Division in Kokrajhar district; 84 ha in Lakhipur Range in Nalbari RF (10 ha), Central Range, Krishnai, Zengrazanga (39 ha), Central Krishnai Zengrazanga (25 ha), Rongjuli Dolngdo Reserve Forest (10 ha) in Goalpara District; and 40 ha in Abhayapuri Range, Aie vally Forest Division in Bongaigaon District of Assam within three years from the date of Stage-II clearance and maintained thereafter by the State Forest Department at the cost of the User Agency. As far as possible, a mixture of local indigenous species shall be planted, and monoculture of any species may be avoided. The CA will be maintained for 10 years.	Cost for raising Compensatory Afforestation for all the locations in three Forest Divisions has been deposited in CAMPA account vide UTR No: ICICR52023041000244178/UBIN0996335/ASSAM CAMPA, dated 10.04.2023. Online payment confirmation enclosed as Annexure-I
3	At the time of payment of the Net Present Value (NPV) at the time of prevailing rate, the User Agency shall furnish an undertaking to pay the additional amount of NPV, if so determined, as per final decision of the Hon'ble Supreme Court of India	Agreed. Undertaking in this regard is enclosed as Annexure-II .
4	The User Agency shall obtain the Environment Clearance as per the provisions of Environment (Protection) Act, 1986, if required (NA).	Not applicable for transmission line projects.
5	No labour camp shall be established on the forest land and fuels preferably the alternated fuel to labourers and the staff working at the site shall be provided so as to avoid any damage and pressure on the nearby forest areas.	Agreed. Undertaking in this regard is enclosed as Annexure-II .
6	The forest land proposed to be diverted shall under no circumstances be transferred to any other agencies.	Agreed. Undertaking in this regard is enclosed as Annexure-II .

	department, or person without prior approval of the Govt. of India.	
7	No damage to the flora and fauna of the adjoining areas shall be caused.	Shall be complied. Undertaking in this regard is enclosed as Annexure-II .
8	The layout of the proposal shall not be changed without prior approval of the central Govt.	Agreed. Undertaking in this regard is enclosed as Annexure-II .
9	The concerned Divisional Forest Officer will monitor and take necessary mitigative measures to ensure that there is no adverse impact on the forests in the surrounding Area.	Noted.
10	The User Agency at its cost shall provide bird deflectors which are to be fixed on the upper conductor of transmission line at suitable interval to avoid bird hits.	The bird deflectors have been installed on the upper conductor of transmission line at suitable interval. Photographs enclosed as Appendix III .
11	The User Agency shall comply all the provision of all Acts, Rules, Regulations, Guidelines, Hon'ble Court Order(s) and NGT Order(s) pertaining to this project, if any, for the time being in force as applicable to the project	Agreed. Undertaking in this regard is enclosed as Annexure-II .
12	The User Agency shall comply with the guidelines for laying transmission through forest areas issued by Ministry vide letter No. 7-25/2012-FC, dated 5/05/2014 & 19/11/2014.	Agreed. Undertaking in this regard is enclosed as Annexure-II .
13	No additional or new path will be constructed inside the forest area for transportation of construction materials for execution of the project work.	Agreed. Undertaking in this regard is enclosed as Annexure-II .
14	The period of diversion under this approval shall be co-terminus with the period of lease to be granted in favour of the user agency or the project life, whichever is less.	Agreed.
15	The forest land shall not be used for any purpose other than that specified in the project proposal.	Agreed. Undertaking in this regard is enclosed as Annexure-II .
16	As per Ministry's letter no 11-30/96-FC (Pt) dt. 14.9.2001 if the compliance of stipulated conditions is awaited from the State Govt for more than 5 (five) years, the in-principle approval would be summarily revoked considering that the user agency is no longer interested in the project.	Agreed.
17	Any other conditions that the Integrated Regional Office, Guwahati, MoEFCC may be stipulated from time to time in the interest of conservation protection and development of Forest & Wildlife	Agreed.

Date: 23/03/2026

Signature:



Name: Narottam Chakraborty

Designation: Head- Forest & Wildlife

Nagalbibra-Bongaigaon Transmission Ltd.

Address of Agency:

Resonia Limited,

5th Floor, RMZ Infinity, Plot No 15

Phase IV, Sec-18, Gurugram, Haryana, 122015.



PARIVESH
 परिवेश
 "Pro Active and Responsive facilitation by Interactive, Virtuous and Environmental Singlwindow Hub"
 Ministry of Environment, Forest and Climate Change
 Government of India

- [Home](#)
- [My Account](#)
- [My Proposals Environment Clearance](#)
- [Only CRZ Clearance](#)
- [My Proposals Forest Clearance](#)
- [My Proposals Wildlife Clearance](#)
- [Help](#)

3:07:26 PM

Online payment history made by User Agency under CAHPA

Help

Sno.	Proposal Detail	Application_No	Application No (New)	Date of TR-PRINCIPLE	Amount to be Paid/Amount Paid (in Rs.)	Payment Status	Payment Detail	Demand Letter
1	EP/AS/TRANS/152968/2022 Construction of 400 KV DC Bongaiyaon Nangalobra Transmission Line	TRANS152968202296894152968966		28 Feb 2023	CA: 96226192/- PCA: 0/- Safety Zone: 0/- NPV: 75053651/- Other Charges1: 0/- Other Charges2: 0/- Other Charges3: 0/- Total: 191645839/-	 Paid	Fund Demand Verified by : 15 Mar 2023 Nodal Officer On : Bank Name : Union Bank Of India Mode of Payment : NIFT/RTGS (Challan) Challan Generated On : 25 Mar 2023 Transaction Date : 11 Apr 2023	Demand Letter Generated Challan











NANGALBIBRA-BONGAIGAON TRANSMISSION LIMITED

DLF Cyber Park Tower-B, 9th Floor, Udyog Vihar Phase-III,
Sector-20, Gurugram-122008, Haryana India +91 0124 4562 000



ANNEXURE- I A

PAYMENT DETAILS

Date	UTR No	Payment Description	Payment Head	Transaction Amount
13/03/2026	UTR No. HDFCR52026031381539908	Wildlife Conservation and Management Plan	CAMPA Assam A/C No. 150617299	1,10,13,814
20/03/2026	NEFT Ref No. NBTL200326R1	Cost of Plantation of Fruits tree for Golden Langur	A/C No. 070805000767	73,03,855
20/03/2026	NEFT Ref No. NBTL200326R1	10 Nos JFMC for 5 years	A/C No. 070805000767	4,65,25,000



(Authorized Signatory)

Narottam Chakraborty
Head- Forest & Wildlife
Nangalbibra Bongaigaon Transmission Ltd.



GOVERNMENT OF ASSAM
OFFICE OF THE PRINCIPAL CHIEF CONSERVATOR OF FORESTS, WILDLIFE AND
CHIEF WILDLIFE WARDEN, ASSAM

Email ID: pccf.wl.assam@gmail.com

No. WL/FG/Proposal/Bongaigaon-Nangalbibra Trans line

Date: **23**.05.2025

To,

The Chief Manger,
Nangalbibra-Bongaigaon Transmission Ltd.,
2nd Floor, Samriddhi Complex, New Market,
Pancharatna Road, Goalpara, Assam-783101.

Sub: Deposition of 2% project cost for Human Elephant/Wildlife Conflict Mitigation & Wildlife Conservation purpose against proposal for “diversion of 61.6 Ha. of forest land for construction of 400 kV D/C Bongaigaon to Nangalbira Transmission Line in Sathbandi RF, Bhairab RF, Pancharatna RF, Sagunbari RF, Zangrazangsa RF, Bogulmari PRF & Rakshashini PRF under haltugaon Division (area-0.66 Ha), Aie Valley Division (area-19.187 Ha) & Goalpara Division (41.747 Ha) by Nangalbibra-Bongaigaon Transmission Ltd”.

Ref: 1. This office letter No. WL/FG/proposal/Bongaigaon-Nangalbibra Trans line, dated 07.06.2023.
2. Your office letter No. NBTL/FOREST/2025-26/01, dated 30.04.2025.

Sir,

Pursuant to the MoEF & CC, Govt of India's F.No. 3 AS B 157/2023-GHY/3649-50, dated 20.02.2023 granting “In Principle Approval/Stage-I” for the above-mentioned proposal and with reference to the subject and letters cited above, it is requested to deposit 2% of the proportionate project cost to the account of CAMPA, as estimated below:

- (a) Total area of the project both in the state of Assam & Meghalaya = 563.772 Ha.
- (b) Total area of project in the state of Meghalaya (non-forest + forest) = 243.496 Ha.
- (c) Total area of the project in the state of Assam (non-forest + forest) = 320.276 Ha.
- (d) Area of forest land proposed for diversion in the state of Assam = 61.6 Ha.
- (e) Proportionate cost of the project in the state of Assam = $320.276/563.772 \times \text{Rs } 504,00,00,000 = \text{Rs } 286,31,98,314/-$
- (f) **2% proportionate project cost** = $61.6/320.276 \times \text{Rs. } 286,31,98,314 \times 2\%$
= Rs 1,10,13,814/-

In view of the above, it is requested to deposit an above-mentioned amount of **Rs 1,10,13,814/- (one crore ten lakhs thirteen thousand eight hundred fourteen only)** for preparation and implementation of Human Elephant/Wildlife Conflict Mitigation & Wildlife Conservation and Management Plan with special emphasis on Golden Langur, in the account of CAMPA.

This is for your kind information and necessary action.

Yours faithfully,



(Dr. Vinay Gupta, IFS)
Principal Chief Conservator of Forests,
Wildlife & Chief Wildlife Warden, Assam.

Copy for information and necessary action to.

1. CCF & Nodal Officer (FC Act), Assam, O/o the PCCF & HoFF, Assam. This has a reference to this office letter No. WL/FG/Proposal/Bongaigaon-Nangalbibra Trans line, dated 26.12.2024 and your letter No. FG.27/FCA/Proposal/Nangalbibra-Bongaigaon Transmission Ltd., dated 18.02.2025.
2. DFO, Goalpara Division, Goalpara, Aie Valley Division, Bongaigaon & Haltugaon Division, Kokrajhar.



Principal Chief Conservator of Forests,
Wildlife & Chief Wildlife Warden, Assam.

Copy for information to Principal Chief Conservator of Forests & Head of Forest Force, Assam, Panjabari, Guwahati-37.



Principal Chief Conservator of Forests,
Wildlife & Chief Wildlife Warden, Assam.



GOVT. OF ASSAM
OFFICE OF THE DIVISIONAL FOREST OFFICER:::AIE VALLEY DIVISION
BONGAIGAON.

E-mail- dfo.t.aievalley@gmail.com

No. B/AVD/Sterlite/400kv/2025/ 3833

Date: 08/07/25

To,

The Chief Manager
Sterlite Power Transmission Limited
2nd Floor, Samriddhi Complex
New Market, Pancharatna Road
Goalpara, Assam-783101

Sub: Demand note for submission of Human Elephant/Wildlife Conflict Mitigation and Wildlife Conservation Plan against the project "Construction of 400 KV DC Nangalbibra-Bongaigaon Transmission Line.

Ref: MoEF & CC Regional Office, Guwahati vide F.No.3 AS B 157/2023 GHY/3649-50, dt. 28.02.2023 &

Your letter No. NBTL/FOREST/2025-26/02, dtd. 06.05.2025

Sir,

With reference to the subject cited above, you are requested to deposit the cost of plantation of fruit bearing species for Golden Langur & fund for 10(ten) nos. J.F.M.C. for implementing different activities within five years around the Bhairab Hill R.F. as per condition no. A.(9)(d) &(e) of the "In Principle Approval/Stage-I" clearance accorded by the Central Government vide Regional Office, Shillong, Ministry of Environment, Forest & Climate Change letter no. F.No. 3 AS B 157/2023 GHY/3649-50, dt. 28.02.2023 against the project "Construction of 400 KV DC Nangalbibra-Bongaigaon Transmission Line. The amount should be deposited in the following Bank Account and the details break up of amount shown below.

- | | | |
|------|---|--------------------------|
| (i) | Cost of raising plantation for fruit bearing species for Golden Langur | Rs. 73,03,855/- |
| (ii) | Cost of 10(ten) nos. J.F.M.C. for different schemes for five years around the Bhairab Hill R.F. | Rs. 4,65,25,000/- |
| | Total= | Rs. 5,38,28,855/- |

In words: (Rupees Five Crore Thirty Eight Lakh Twenty Eight Thousand Eight hundred Fifty Five) only

Bank Details:

Name of A/C holder : Divisional Forest Officer,
Aie Valley Division, Bongaigaon
Name of Bank : ICICI Bank, Bongaigaon Branch
Account No. : 70805000767
IFSC : ICIC0000708

This is for your kind information and necessary action.

Yours faithfully

Habin
08/07/25
Divisional Forest Officer
Aie Valley Division
Bongaigaon

Date: 08/07/25

No. A/AVD/Sterlite/400kv/2025/ 3583-85

Copy to:

1. The Principal Chief Conservator of Forests, Wildlife & Chief Wildlife Warden, Assam, Panjabari, Guwahati-37 for favour of his kind information and necessary action.
2. The Chief Conservator of Forests & Nodal Officer (F.C. Act), Assam the Conservator of Forests, Lower Assam Social Forestry Circle, Bongaigaon for favour of his kind information.
3. The Conservator of Forests, Lower Assam Social Forestry Circle, Bongaigaon for favour of his kind information.

6/c

Habin
08/07/25
Divisional Forest Officer
Aie Valley Division
Bongaigaon

Norms for 20 ha Artificial Regeneration (AR) plantation with fruit bearing trees

Area (ha) = 20
 Spacing (m x m) = 2X2
 Wage Rate as per latest CAMPA norms = Rs 353
 Total quantity of saplings to be planted = 50,000 nos
 Total quantity of saplings to be raised/purchased = 82,500 nos

Sl no	Particulars of work	Units	Qty./Ha	Total Qty.	Rate/Unit	Amount (Rs.)
7	3RD YEAR MAINTENANCE					
	4 weeding, mulching and fire protection works @ 20 DLs/ha weeding	DLs	80	1600	353	5,64,800
	15% vacancy filling by 2 years old seedling from site nursery/CAMPA nursery	DLs	23	460	353	1,62,380
	Maintenance and protection of field nursery and 1 no. watch and ward for the plantation area for 365 days	DLs	1	365	353	1,28,845
	Maintenance of Camp Hut, implement, upkeep of plantation signboard, documentation, upkeep of records etc	LS				5000
	Contingency	LS				15,000
	Sub Total					8,76,025
8	4TH YEAR MAINTENANCE					
	4 weeding, mulching and fire protection works @ 15 DLs/ha/weeding	DLs	60	1200	353	5,64,800
	10% vacancy filling by 3 years old seedling from site nursery/CAMPA nursery	DLs	20	400	353	1,41,200
	Maintenance and protection of field nursery and 1 no. watch and ward for the plantation area for 365 days	DLs	1	365	353	1,28,845
	Maintenance of Camp Hut, implement, upkeep of plantation signboard, documentation, upkeep of records etc	LS				5000
	Contingency	LS				15,000
	Sub Total					8,54,845
9	5TH YEAR MAINTENANCE					
	3 weeding, climber cutting & other silvicultural works and fire protection works @ 15 DLs/ha	DLs	45	900	353	3,17,700
	Maintenance and protection of field nursery and 1 no. watch and ward for the plantation area for 365 days	DLs	1	365	353	1,28,845
	Maintenance of Camp Hut, implement, upkeep of plantation signboard, documentation, upkeep of records etc	LS				5000
	Contingency	LS				15,000
	Sub Total					4,66,545
	GRAND TOTAL					73,03,855

Approved by

 Conservator of Forests
 Lower Assam Social Forestry Circle
 Bongaigaon

Countersigned by

 Divisional Forest Officer
 Ate Valley Division
 Bongaigaon

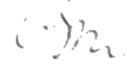
Submitted by

 Forest Range Officer
 Abhayapuri Range
 Abhayapuri

Bond		Indian-Non Judicial Stamp Haryana Government		Date : 18/03/2026	
Certificate No.	G0R2026C574		Stamp Duty Paid : ₹ 101 <small>(Rs. Only)</small>		
GRN No.	148841143		Penalty : ₹ 0 <small>(Rs. Zero Only)</small>		
Deponent					
Name :	Nangal Bibra bongaigaon Transmission Ltd				
H.No/Floor :	Na	Sector/Ward :	20	Landmark :	Tower b dlf cyber park
City/Village :	Gurugram	District :	Gurugram	State :	Haryana
Phone :	95*****48				
					
Purpose : FOR SUBMISSION OF COMPLIANCE to be submitted at Concerned office					

The authenticity of this document can be verified by scanning this QrCode Through smart phone or on the website <https://egrashry.nic.in>

Annexure-II

Undertaking for compliance with the conditions of the in-principle approval No. 3-AS B157/2023-GHY/3649-50, dated 28.02.2023, for the diversion of 61.6 ha of forest land for construction of 400 kV D/C Bongaigaon to Nangalbibra Transmission line under Haltugaon, Aie Valley, and Goalpara Forest divisions:



- 1) As per condition No. 2 A (15) of the IPA we, Nangalbibra-Bongaigaon Transmission Ltd. do hereby undertake that **“no violation of any of the conditions shall be done and accept that violation of any of these conditions will amount to violation of forest conservation Act, 1980.”**
- 2) As per condition No. 2 B (1) of the IPA we, Nangalbibra-Bongaigaon Transmission Ltd. do hereby undertake that **“Legal status of forest land proposed for diversion shall remain unchanged.”**
- 3) As per condition No. 2 B (3) of the IPA we, Nangalbibra-Bongaigaon Transmission Ltd. do hereby undertake that **“additional amount of NPV, if so determined, as per final decision of the hon’ble supreme court of India shall be paid by us”.**
- 4) As per condition No. 2 B (5) of the IPA we, Nangalbibra-Bongaigaon Transmission Ltd. do hereby undertake that, **“no labour camp shall be established on the forest land and fuels preferably the alternated fuel to labourers and the staff working at the site shall be provided so as to avoid any damage and pressure on the nearby forest areas.**

- 5) As per condition No. 2 B (6) of the IPA we, Nangalbibra-Bongaigaon Transmission Ltd. do hereby undertake that **“the forest land proposed to be diverted shall under no circumstances be transferred to any other agencies, department or person without prior approval of Govt. of India”**.
- 6) As per condition No. 2 B (7) of the IPA we, Nangalbibra-Bongaigaon Transmission Ltd. do hereby undertake that **“no damage to the flora and fauna of the adjoining areas shall be caused.”**
- 7) As per condition No. 2 B (8) of the IPA we, Nangalbibra-Bongaigaon Transmission Ltd. do hereby undertake that **“layout of the proposal shall not be changed without the prior approval of the Central Government.”**
- 8) As per condition No. 2 B (11) of the IPA we, Nangalbibra-Bongaigaon Transmission Ltd. do hereby undertake that, **“compliance of all acts, rules, regulations, guidelines, the hon’ble court order(s) and NGT order(s) pertaining to this project, if any, for the time being in force as applicable to the project”**.
- 9) As per condition No. 2 B (12) of the IPA we, Nangalbibra-Bongaigaon Transmission Ltd. do hereby undertake **“to comply with the guidelines for laying transmission lines through forest areas issued by Ministry vide letter No- 7-25/2012/FC dated 05.05.2014 & 19/11/2014”**.
- 10) As per condition No. 2 B (13) of the IPA we, Nangalbibra-Bongaigaon Transmission Ltd. do hereby undertake that, **“no additional or new path will be constructed inside forest area for transportation of construction materials for execution of the project work”**.
- 11) As per condition No. 2 B (15) of the IPA we, Nangalbibra-Bongaigaon Transmission Ltd. do hereby undertake that, **“forest land shall not be used for any purpose other than that specified in the project proposal”**.

Date: 23/03/2026

Place: Goalpara

Signature:

Name: Narottam Chakraborty
Designation: Head- Forest & Wildlife
Nangalbibra Bongaigaon Transmission Ltd.

Address of Agency:

Resonia Limited,
5th Floor, RMZ Infinity, Plot No 15
Phase IV, Sec-18, Gurugram, Haryana, 122015



FORM-I

(for linear projects)
Government of Assam
Office of the Deputy Commissioner,
Goalpara

No. Rev/1487/2023-REV-GLP/71

Dated : 03rd June, 2023**TO WHOM SO EVER IT MAY CONCERN**

In compliance of the Ministry of Environment and Forests (MoEF), Government of India's letter No.11-9/98-FC(pt.) dated 3rd August, 2009, wherein the MoEF issued guidelines on submission of evidences for having initiated and completed the process of settlement of rights under the Scheduled Tribes and Other Traditional Forest Dwellers (Recognition of Forest Right) Act, 2006 ('FRA', for short) on the forest land proposed to be diverted for non-forest purposes read with MoEF's letter dated 5th February, 2013, wherein MoEF issued certain relaxation in respect of linear projects, it is certified that **41.747** hectares of forest land proposed to be diverted in favour of Sterlite Power for Construction of 400 KV D/C Bongaigaon-Nangalbibra Transmission Line in Goalpara district falls within jurisdiction of Pancharatna Hill RF, Bagulamari PRF, Sagunbahi RF, Rakhyasini PRF and Zangrajangsa RF under Balijana Tehsil.

It is further certified that:

- (a) The complete process for identification and settlement of rights under the FRA has been carried out for the entire.....hectares of forest area proposed for diversion. A copy of records of all consultations and meetings of the Forest Rights Committee (s), Gram Sabha (s), Sub-Division Level Committee (s) and the District Level Committee are enclosed as annexure.....to.....annexure.....(**Not Applicable**)
- (b) The diversion of forest land for facilities managed by the Government as required under section 3 (2) of the FRA have been completed and the Grama Sabhas have given their consent to it; (**Not Applicable**)
- (c) The proposal does not involve recognized right of Primitive Tribal Groups and Pre-agricultural communities.

**Signed by Khanindra
Choudhury**

Date: 03-06-2023 17:27:08

(Shri Khanindra Choudhury, IAS)
Deputy Commissioner,
Goalpara

Forest Land Boundary Demarcation by Concrete Pillars



Three Layer Protection Measures implemented on Towers at Bhairab Forest to Restrict Climbing of Arboreal Animals

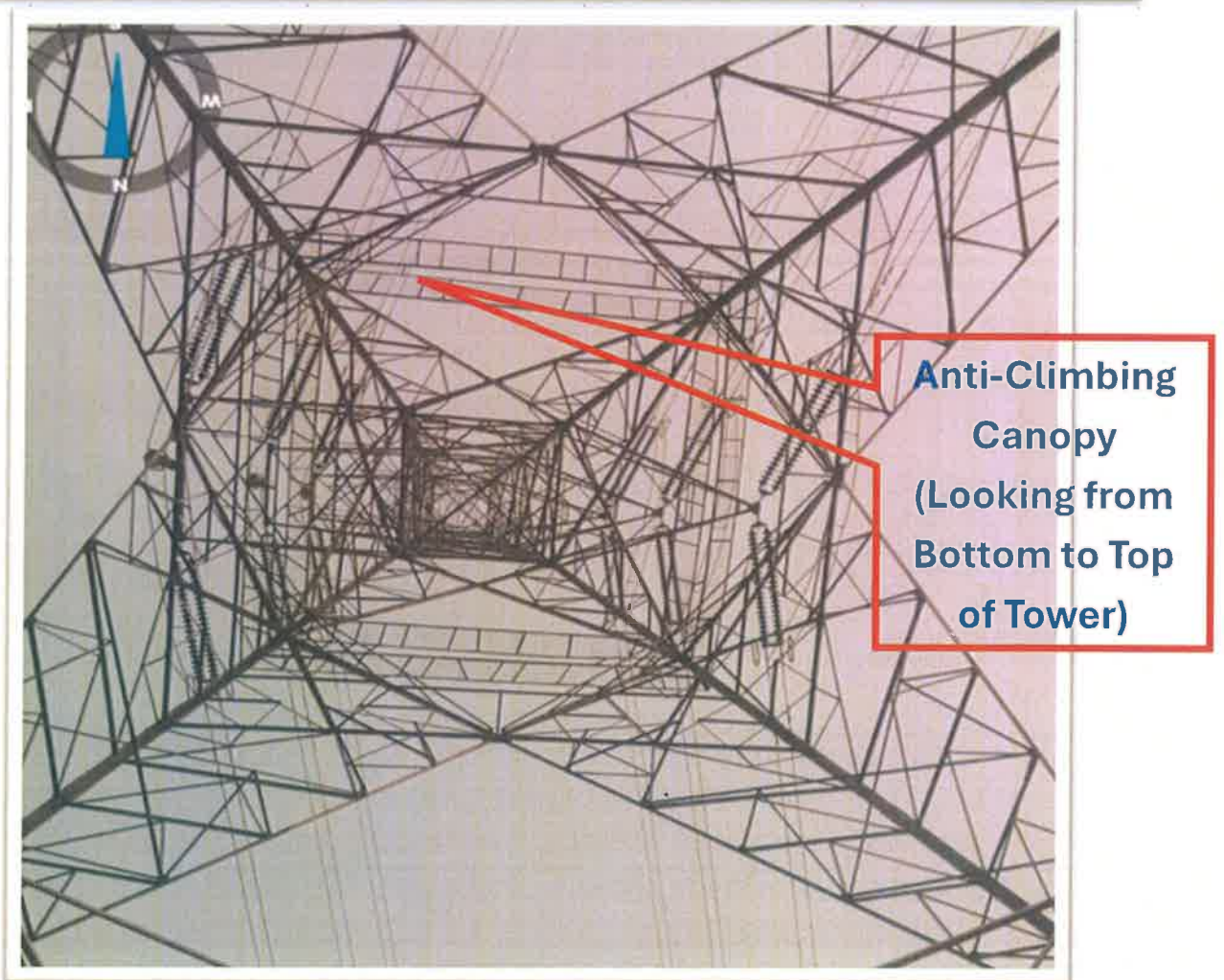
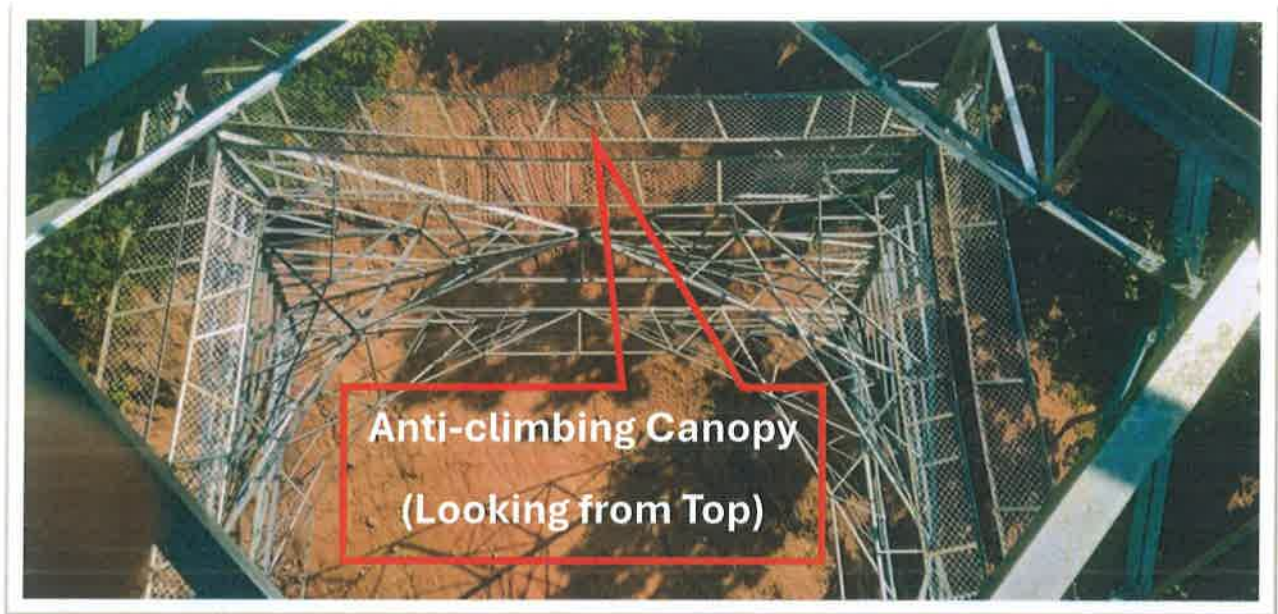

Three Layer Protection Measures implemented on Towers at Bhairab Forest to Restrict Climbing of Arboreal Animals

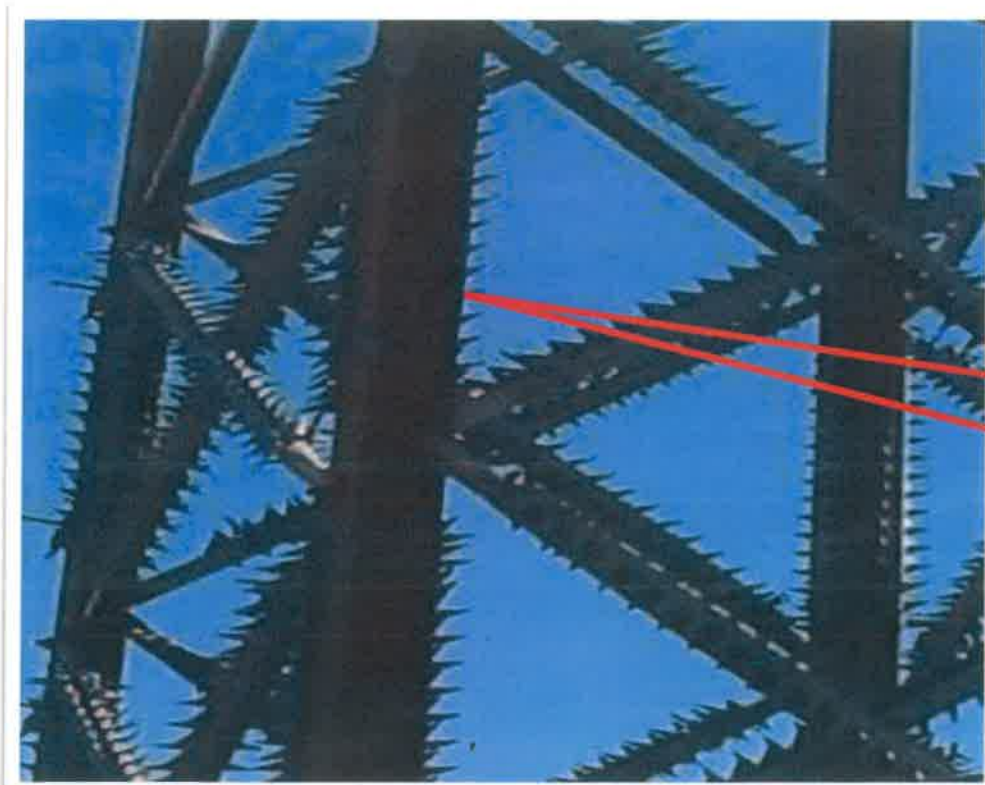

**Anti-Climbing
Guards**



**Anti-Climbing
Device with
Barbed wire
Fencing**

Bird Deflectors Installed on Upper Conductor of Transmission Line in Forest Land.



Sr. No	PART Description (BOM)	Description	QTY
A	UNIVERSAL CLAMP	High Grade Engineering Polymer	1
B	CONNECTING ROD	STAINLESS STEEL - corrosion free	1
C	HIGH TENSILE SPRING	STAINLESS STEEL - corrosion free	2
D	HOLDING SHAFT	STAINLESS STEEL - corrosion free	2
E	ROTATING MECHANISM	Self lubricating ball bearing with High Grade Engineering Polymer Case Cover	1
F	FLAPPER Ø195MM	High grade engineering Polymer	1

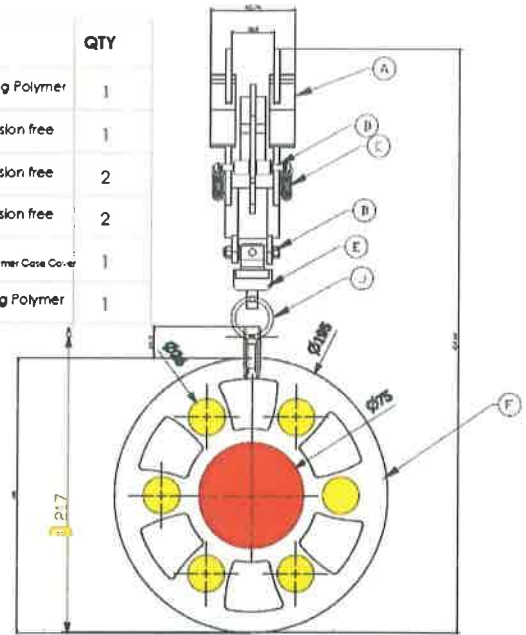

Bird Deflector installed on top conductor

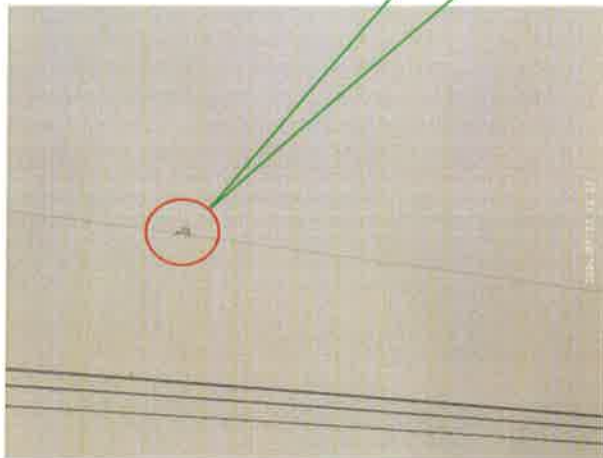

Bird Deflector installed on top conductor

