

**GOVERNMENT OF ASSAM
ENVIRONMENT, FOREST AND CLIMATE CHANGE DEPARTMENT
DISPUR, GUWAHATI-6**

No. 267539/I/1577983/2026

Dated Dispur, 29-05-2026

To : The Deputy Director General of Forest (Central),
Sub Office, Guwahati (Under Regional Office, Shillong)
4th Floor, Housefed Building, G.S Road,
Rukminigaon, Guwahati-781022

Sub : Regarding COMPLIANCE REPORT against the proposal for diversion of 61.6 Ha. (19.187 Ha. in Aie Valley Divn, 41.747 Ha. in Goalpara Divn., 0.666 Ha. in Haltugaon Divn.) forest area for construction of 400 KV D/C Nanglabibra Bongaigaon Transmission line.

Ref : Letter No. FG.27/FCA/Proposal/Nangalbibra-Bongaigaon Trans Ltd. dtd. 5-5-2026.

Sir,

With reference to the subject cited above, I am directed to forward herewith the COMPLIANCE REPORT against the proposal for diversion of 61.6 Ha. (19.187 Ha. in Aie Valley Divn, 41.747 Ha. in Goalpara Divn., 0.666 Ha. in Haltugaon Divn.) forest area for construction of 400 KV D/C Nanglabibra Bongaigaon Transmission line as received from the CCF & Nodal Officer (FC Act), o/o PCCF & HoFF, Assam, vide letter under reference, for your perusal & necessary action on the matter.

Enclo : As stated above.

Yours faithfully,

**Digitally signed by
Ramen Chandra Malakar
Date: 29-05-2026
16:13:31**

Commissioner & Secretary to the Govt. of Assam,
Environment, Forest and Climate Change Department

Memo No. 267539/I/1577983/2026-A

Dated Dispur, 29-05-2026

Copy forwarded to:

The Principal Chief Conservator of Forests & Head of Forest Force,
Assam, Panjabari, Guwahati-37.

(e-signed)

Commissioner & Secretary to the Govt. of Assam
Environment, Forest and Climate Change Department

M
1375
OSD(5)

GOVERNMENT OF ASSAM
OFFICE OF THE PRINCIPAL CHIEF CONSERVATOR OF FORESTS AND
HEAD OF FOREST FORCE, ASSAM
ARANYA BHAWAN, PANJABARI, GUWAHATI-781005



Email: addipocf.nodal@gmail.com

No. FG.27/FCA/Proposal/Nangalbibra-Bongaigaon Trans Ltd.

Date: 05.05.2026

To

The Special Chief Secretary (Forest) to the Government of Assam,
Environment, Forest & Climate Change Department,
Dispur, Guwahati-6.

Sub:

Submission of Compliance Report of the conditions laid down in the "In-Principal approval/Stage-I" for forest diversion proposal of 61.6 Ha. forest land for construction of 400 KV DC Bongaigaon to Nangalbibra Transmission Line in Satbhandi RF, Bhairab RF, Panchratna RF, Sagunbari RF, Zangrazangsa RF, Bogulamari PRF & Rakshasini PRF under Haltugaon Division (area-0.666 ha), Aie Valley Division (area-19.187 ha) & Goalpara Division (area-41.747 ha) in favour of Nangalbibra-Bongaigaon Transmission Limited – reg.

Ref:

Government of India letter No. 3 AS B 157/2023-GHY/3649-50 dated 28.02.2023.

Sir,

With reference to the subject and letter cited above, I am directed to submit herewith the report regarding compliance of the conditions enlisted in the Central Government's "In-Principle Approval" issued vide letter No. 3 AS B 157/2023-GHY/3649-50 dated 28.02.2023 for the above-mentioned forest diversion proposal as given below:

| Condition No. A | Compliance Report/Remarks |
|-----------------|--|
| 1 | The User Agency (Nangalbibra-Bongaigaon Transmission Limited) has deposited Rs. 7,50,53,651/- for Net Present Value of the forest land to be diverted. |
| 2 | The User Agency (Nangalbibra-Bongaigaon Transmission Limited) has deposited Rs. 9,62,26,192/- for raising of Compensatory Afforestation. |
| 3 | The User Agency (Nangalbibra-Bongaigaon Transmission Limited) has deposited a total amount of Rs. 20,28,59,653/- into Ad-hoc CAMPA account through online web portal (www.parivesh.nic.in) of MoEF&CC on 11.04.2023 & 13.03.2026 (copy enclosed). The details are as follows: Net Present Value = Rs. 7,50,53,651.00 Compensatory Afforestation = Rs. 6,42,11,144.00 Over Head Cost = Rs. 3,20,15,048.00 Dwarf Species Plantation = Rs. 2,05,65,996.00 2% of the project cost for Wildlife Conservation Plan = Rs. 1,10,13,814.00 Total Rs. 20,28,59,653.00 |
| 4 | The KML file of proposed diversion area and Compensatory Afforestation area uploaded in e-Green watch Portal (copy enclosed). |
| 5 | The boundary of the diverted forest land has been demarcated on ground at the project cost, by erecting four feet high RCC pillars, each inscribed with its serial number and GPS coordinates by the DFOs, Haltugaon Division, Aie Valley Division & Goalpara Division respectively (photographs enclosed). |
| 6 | The User Agency (Nangalbibra-Bongaigaon Transmission Limited) has deposited Rs. 1,10,13,814/- towards 2% of the project cost for Human Elephant Conflict Mitigation & Wildlife Conservation purpose to the Ad-hoc CAMPA account. |
| 7 | The User Agency (Nangalbibra-Bongaigaon Transmission Limited) has submitted undertaking for condition No. 7 laid down in the "In Principle Approval" (copy enclosed). |

Off :e Of The Special
Chief Secretary
To The Govt. Of Assam
Environment & Forest Deptt.
ECR / Dy.No. 1346
Dated 12/05/26

H.C.
15/05/26

| | |
|----|---|
| 8 | In view of the urgency expressed by the User Agency for expeditious approval of the proposal, it is requested to approve the proposal for Stage-II in accordance with the provisions of MoEF & CC, Govt. of India Notification No. FC-11/43/2021-FC dated 07.06.2022 & FC-11/135/2024-FC dated 26.12.2024. The User Agency (Nangalbibra-Bongaigaon Transmission Limited) has already deposited Rs. 1,10,13,814/- towards 2% of the Project Cost for Human Elephant Conflict Mitigation & Wildlife Conservation purpose to the CAMPA account. The preparation of Wildlife Conservation & Conflict Mitigation Plan is under process and will be submitted shortly. |
| 9 | <ul style="list-style-type: none"> a) The User Agency (Nangalbibra-Bongaigaon Transmission Limited) has mentioned ground clearance has been maintained minimum of 15 m along the route in Bhairab RF (Copy enclosed) b) The User Agency (Nangalbibra-Bongaigaon Transmission Limited) has mentioned three-layer protection measures have been adopted at all the towers in Bhairab RF. Photographs enclosed. c) The User Agency (Nangalbibra-Bongaigaon Transmission Limited) has deposited Rs. 1,10,13,814/- towards 2% of the project cost for Human Elephant Conflict Mitigation & Wildlife Conservation purpose to the Ad-hoc CAMPA account. d) The User Agency (Nangalbibra-Bongaigaon Transmission Limited) has deposited Rs. 73,03,855/- towards plantation of fruit trees especially for Golden Langur to the DFO, Aie Valley Division. e) The User Agency (Nangalbibra-Bongaigaon Transmission Limited) has deposited Rs. 4,65,25,000/- towards supporting 10 Nos. of JFMCs for five years in and around Bhairab RF and other nearby forest to the DFO, Aie Valley Division. f) The User Agency (Nangalbibra-Bongaigaon Transmission Limited) has mentioned felling of trees have been restricted at tower locations and bare minimum in the corridor to maintain safe electrical clearance as per Indian standard (Copy enclosed) |
| 10 | The User Agency (Nangalbibra-Bongaigaon Transmission Limited) has submitted undertaking for condition No. 10 laid down in the "In Principle Approval" (copy enclosed). |
| 11 | The User Agency (Nangalbibra-Bongaigaon Transmission Limited) has deposited the cost for felling, logging & transportation of project affected trees to the DFOs, Haltugaon Division, Aie Valley Division & Goalpara Division respectively (copy enclosed). |
| 12 | The boundary of the diverted forest land has been demarcated on ground at the project cost, by erecting four feet high RCC pillars, each inscribed with its serial number and GPS co-ordinates by the DFOs, Haltugaon Division, Aie Valley Division & Goalpara Division respectively (photographs enclosed). |
| 13 | The User Agency (Nangalbibra-Bongaigaon Transmission Limited) has submitted undertaking for condition No. 13 laid down in the "In Principle Approval" (copy enclosed). |
| 14 | The User Agency (Nangalbibra-Bongaigaon Transmission Limited) has submitted FRA-2006 certificate (copy enclosed). |
| 15 | The User Agency (Nangalbibra-Bongaigaon Transmission Limited) has submitted undertaking for condition No. 15 laid down in the "In Principle Approval" (copy enclosed). |
| 16 | The User Agency (Nangalbibra-Bongaigaon Transmission Limited) has deposited Rs. 2,05,65,996/- for Dwarf Species Plantation. |
| 17 | The User Agency (Nangalbibra-Bongaigaon Transmission Limited) has uploaded the compliance report on e-portal. |

| Condition No. B | Compliance Report/Remarks |
|-----------------|---|
| 1 | The User Agency (Nangalbibra-Bongaigaon Transmission Limited) has submitted undertaking for condition No. (1) laid down in the "In Principle Approval" (Copy enclosed) |
| 2 | The User Agency (Nangalbibra-Bongaigaon Transmission Limited) has deposited Rs. 9,62,26,192/- for raising of Compensatory Afforestation. |
| 3 | The User Agency (Nangalbibra-Bongaigaon Transmission Limited) has submitted undertaking for condition No. (3) laid down in the "In Principle Approval" (Copy enclosed) |
| 4 | The User Agency (Nangalbibra-Bongaigaon Transmission Limited) has mentioned Environment Clearance not applicable for transmission line (Copy enclosed). |
| 5 | The User Agency (Nangalbibra-Bongaigaon Transmission Limited) has submitted undertaking for condition No. (5) laid down in the "In Principle Approval" (Copy enclosed) |
| 6 | The User Agency (Nangalbibra-Bongaigaon Transmission Limited) has submitted undertaking for condition No. (6) laid down in the "In Principle Approval" (Copy enclosed) |
| 7 | The User Agency (Nangalbibra-Bongaigaon Transmission Limited) has submitted undertaking for condition No. (7) laid down in the "In Principle Approval" (Copy enclosed) |
| 8 | The User Agency (Nangalbibra-Bongaigaon Transmission Limited) has submitted undertaking for condition No. (8) laid down in the "In Principle Approval" (Copy enclosed) |
| 9 | The User Agency (Nangalbibra-Bongaigaon Transmission Limited) has submitted undertaking for condition No. (9) laid down in the "In Principle Approval" (Copy enclosed) |
| 10 | The User Agency (Nangalbibra-Bongaigaon Transmission Limited) has stated that the bird deflectors have been installed on the upper conductor of transmission line at suitable interval. Photographs is enclosed herewith (Copy enclosed). |
| 11 | The User Agency (Nangalbibra-Bongaigaon Transmission Limited) has submitted undertaking for condition No. (11) laid down in the "In Principle Approval" (Copy enclosed) |
| 12 | The User Agency (Nangalbibra-Bongaigaon Transmission Limited) has submitted undertaking for condition No. (12) laid down in the "In Principle Approval" (Copy enclosed) |
| 13 | The User Agency (Nangalbibra-Bongaigaon Transmission Limited) has submitted undertaking for condition No. (13) laid down in the "In Principle Approval" (Copy enclosed) |
| 14 | The User Agency (Nangalbibra-Bongaigaon Transmission Limited) has submitted undertaking for condition No. (14) laid down in the "In Principle Approval" (Copy enclosed) |
| 15 | The User Agency (Nangalbibra-Bongaigaon Transmission Limited) has submitted undertaking for condition No. (15) laid down in the "In Principle Approval" (Copy enclosed) |
| 16 | The User Agency (Nangalbibra-Bongaigaon Transmission Limited) has submitted undertaking for condition No. (16) laid down in the "In Principle Approval" (Copy enclosed) |
| 17 | The User Agency (Nangalbibra-Bongaigaon Transmission Limited) has submitted undertaking for condition No. (17) laid down in the "In Principle Approval" (Copy enclosed) |

Therefore, you are requested to kindly forward the compliance report to the Government of India, MoEF & CC, Sub Office under Regional Office, Guwahati for onward necessary action.

Encl: As above.

Yours faithfully,

(Dr. C Muthukumaravel, IFS)
 Chief Conservator of Forests &
 Nodal Officer (FC Act), Assam
 O/o the Principal Chief Conservator of Forests and
 Head of Forest Force, Assam

Copy for information to:

1. The Deputy Director General of Forest (Central), Sub Office, Guwahati (under Regional Office, Shillong), Government of India, Ministry of Environment, Forest & Climate Change, 4th Floor, Housefed Building, G.S. Road, Rukminigaon, Guwahati.
2. The Addl. Principle Chief Conservator of Forests cum CHD, BTC, Kokrajhar.
3. The Addl. Principle Chief Conservator of Forests (T), Lower Assam Zone, Basistha, Guwahati.
4. The Conservator of Forests, Lower Assam Social Forestry Circle, Bongaigaon and Central Assam Circle, Guwahati.
5. The Divisional Forest Officer, Haltugaon Division, Kokrajhar / Aie Valley Division, Bongaigaon / Goalpara Division, Goalpara.
6. The Chief Manager, Nangalbibra-Bongaigaon Transmission Limited, 2nd Floor, Samriddhi Complex, New Market, Pancharatne Road, Goalpara.

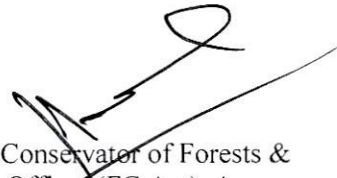

Chief Conservator of Forests &
Nodal Officer (FC Act), Assam
O/o the Principal Chief Conservator of Forests and
Head of Forest Force, Assam

**DIVERSION PROPOSAL OF FOREST LAND FOR CONSTRUCTION OF 400KV D/C
BONGAIGAON TO NANGALBIBRA TRANSMISSION LINE
PROPFORMA**

| | | |
|----|--|--|
| 1 | State/ District /Forest Division to which the proposal relates | Assam/ Kokrajhar, Bongaigaon & Goalpara / Haltugaon Division, Aie Valley Division & Goalpara Division. |
| 2 | Name of User Agency, nature of proposal | The Chief Manager, Nangalbibra-Bongaigaon Transmission Limited, 2 nd Floor, Samridhi Complex, New Market, Pancharatne Road, Goalpara. Forest diversion proposal for construction of 400 KV DC Bongaigaon to Nangalbibra Transmission Line. |
| 3 | Extent of Forest area involved | 61.6 hectare of Reserved Forest area |
| 4 | Whether original, or extension | Original |
| 5 | If extension of lease, please clarify if proposal involves additional forest area, and if so, specify | Does not arise. |
| 6 | Date of 1 st stage clearance | 28.02.2023. |
| 7 | Extent of CAMPA charges, head wise viz. | |
| | (a) Compensatory Afforestation | Rs. 6,42,11,144.00 |
| | (b) Additional CA. | NIL |
| | (c) Penal CA | NIL |
| | (d) Catchment Area Treatment | NIL |
| | (e) Wildlife Management Plan | Rs. 1,10,13,814.00 |
| | (f) Additional charges for diversion of area falling under notified/ protected areas | NIL |
| | (g) Net Present Value | Rs. 7,50,53,651.00 |
| | (h) Any other charges/ Levies (Pl specify) | Over Head Cost - Rs. 3,20,15,048.00 Dwarf Species Plantation - Rs. 2,05,65,996.00 |
| 8 | Details of Bank Drafts (Bank, Draft No, Date & Amount), head wise against items indicated in paragraph 7 above | NIL |
| 9 | Whether deposited by RTGS, if so the particulars and date of remittance | The User Agency has deposited an amount of Rs. 19,18,45,839/- & Rs. 1,10,13,814.00/-into the Ad-hoc CAMPA account through online web portal (www.parivesh.nic.in) of MoEF & CC on 11.04.2023 & 13.03.2026 |
| 10 | Bank (Corporation Bank, Lodhi Complex/ Union Bank of India, Sunder Nagar) in which deposited with date deposition. | As stated in column No. 9 above. |
| 11 | Any other remarks | NIL |

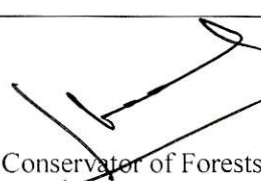
 Chief Conservator of Forests &
 Nodal Officer (FC Act), Assam
 O/o the Principal Chief Conservator of Forests and
 Head of Forest Force, Assam



FCA Projects, Diverted Land, CA Land Management

Home FCA-1980 Projects Diverted Lands CA Lands Reports

Detailed Summary of Selected FCA Project

Project Basic details

| S.No. | Project Name | Project Year | Project Type | Purpose of Diversion | Total Land Diverted | User Agency |
|-------|--|--------------|-------------------|--|---------------------|-------------|
| 1 | Construction of 400 kV DC Bongaigaon Nangalbibra Transmission Line | 2023 | Transmission Line | Diversion of 61.600 ha of Forest Area for Construction of 400 kV DC Bongaigaon Nangalbibra Transmission Line under Haltugaon, Aie valley and Goalpara Forest Divisions | 61.600 | |

Details of Diverted forest land

| S.No. | Area Diverted (In Hac) | Division | Range | Forest Type | Location |
|-------|------------------------|------------|---------------|---|-----------------|
| 1 | 0.666 | Haltugaon | Nayekgaon | Reserved Forest (RF) | Satbhendi RF |
| 2 | 10.355 | Goalpara | Goalpara | Reserved Forest (RF) | Pancharatna RF |
| 3 | 16.325 | Goalpara | Goalpara | Proposed Protected Forest (Proposed PF) | Bogulamari PRF |
| 4 | 1.976 | Goalpara | Goalpara | Reserved Forest (RF) | Sagunbasi RF |
| 5 | 4.085 | Goalpara | Goalpara | Proposed Protected Forest (Proposed PF) | Rakshasini PRF |
| 6 | 9.006 | Goalpara | Consolidation | Reserved Forest (RF) | Zangrazangsa RF |
| 7 | 19.187 | Aie Valley | Abhayapuri | Reserved Forest (RF) | Bhairab RF |

Details of Lands received from user agency for Compensatory Afforestation

| S.No. | Land Type | Area(in Ha) | District | Range | Notification order No. |
|-------|--------------------------|-------------|----------|----------------------------|------------------------|
| 1 | Degraded Notified Forest | 1.350 | | Nayekgaon [Haltugaon] | |
| 2 | Degraded Notified Forest | 10.000 | | Lakhipur [Goalpara] | |
| 3 | Degraded Notified Forest | 39.000 | | Consolidation [Goalpara] | |
| 4 | Degraded Notified Forest | 25.000 | | Consolidation [Goalpara] | |
| 5 | Degraded Notified Forest | 10.000 | | Rongjuli [Goalpara] | |
| 6 | Degraded Notified Forest | 40.000 | | Abhayapuri [Aie Valley] | |

Details of the amount demanded from UA against the FCA project

| S.No. | FCA Proj. File No | Project Name | State | Proj. Year | Order No. | Date | NPV | CA | ACA | PCA | PAF | CAT | SZ | Others | Total Demanded | |
|-------|-------------------------|--|-------|------------|----------------------|------------|----------|----------|-----|-----|-----|-----|----|----------|----------------|-----------|
| 1 | FP/AS/TRANS/152968/2022 | Construction of 400 kV DC Bongaigaon Nangalbibra Transmission Line | AS | 2023 | A/HFD/LD/NDTL/390-91 | 09/06/2023 | 75053651 | 64211144 | 0 | 0 | 0 | 0 | 0 | 63594858 | 202859653 | |
| Total | | | | | | | 75053651 | 64211144 | 0 | 0 | 0 | 0 | 0 | 0 | 63594858 | 202859653 |

Details of the amount received from UA against the FCA project.

| S.No. | FCA Project File No | Proj. Name | State | Proj. Year | Ref. No. | Ref. Date | Receipt Date | NPV | CA | ACA | PCA | PAF | CAT | SZ | Others | Total Received |
|-------|-------------------------|--|-------|------------|----------------------|------------|--------------|----------|----------|-----|-----|-----|-----|----|----------|----------------|
| 1 | FP/AS/TRANS/152968/2022 | Construction of 400 kV DC Bongaigaon Nangalbibra Transmission Line | AS | 2023 | A/HFD/LD/NDTL/390-91 | 09/06/2023 | 11/07/2023 | 75053651 | 64211144 | 0 | 0 | 0 | 0 | 0 | 63594858 | 202859653 |
| Total | | | | | | | | 75053651 | 64211144 | 0 | 0 | 0 | 0 | 0 | 63594858 | 202859653 |

Lock and Print Details

Go Back

NANGALBIBRA-BONGAIGAON TRANSMISSION LIMITEDDLF Cyber Park Tower-B, 9th Floor, Udyog Vihar Phase-III,
Sector-20, Gurugram-122008, Haryana India +91 0124 4562 000

Date: 23-03-2026

To,

The Divisional Forest Officer,
Goalpara Forest Division,
Goalpara, AssamSub: Proposal for diversion of 61.6 ha (19.187 ha in Aie Valley Division, 41.747 in Goalpara Division, 0.666 ha in Haltugaon Division) forest area for construction of 400 kV D/C Bongaigaon-Nangalbibra Transmission line– *submission of pointwise compliance report of the in-principle approval and request for processing the proposal for issuance of final approval.*

Ref:

1. In-Principle approval accorded by the MoEFCC, IRO Shillong vide F. No. 3 -AS B 157/2023 -GHY/3649-50, dated 28.02.2023.
2. Demand note raised by the DFO vide letter No. B/GLP/DFO(T)/FCA/Diversion Proposal/Sterlite Power/1402, dated 13.03.2023.
3. Demand letter of the PCCF Wildlife and Chief Wildlife Warden, Assam vide No. WL/FG/Proposal/Bongaigaon-Nangalbibra Trans line, dated 23.05.2025
4. Demand letter raised from the DFO, Aie Valley Division, Bongaigaon vide letter no. B/AVD/Sterlite/400kv/2025/3833, dated 08.07.2025.

Dear Sir,

With reference to the above, please find enclosed the revised pointwise compliance report of the In-Principle approval accorded by the MoEFCC, IRO Shillong vide F. No. 3-AS B 157/2023GHY/3649-50, dated 28th February 2023 along with necessary enclosures.

All the compensatory levies have been deposited to the Ad-hoc CAMPA Account and the given account of the DFO, Aie Valley which are tabulated below for ready reference.

| Txn Posted Date | UTR No./ Description | Payment head | Transaction Amount (INR) |
|-----------------|---|--|--------------------------|
| 10/04/2023 | RTGS: ICICR52023041000244886/ UBIN0996335/ASSAMCAMP | NPV, CA, Overhead Cost and Medicinal Plantation in CAMPA through e-challan | 12,62,76,457 |
| 27/04/2023 | UTR No. ICICR52023052300638561/SBIN00000 82/DIVISIONAL FOREST OFFICER | Erection of boundary pillars | 6,61,196 |
| 27/04/2023 | UTR No. ICICR52023052300638561/SBIN0000 082/DIVISIONAL FOREST OFFICER | Departmental operation | 14,57,700 |

NANGALBIBRA-BONGAIGAON TRANSMISSION LIMITED

DLF Cyber Park Tower-B, 9th Floor, Udyog Vihar Phase-III,
Sector-20, Gurugram-122008, Haryana India +91 0124 4562 000



| | | | |
|------------|---|--|-------------|
| 27/04/2023 | UTR No. ICICR52023052300638561/SBIN0000 082/DIVISIONAL FOREST OFFICER | Maintenance timber depot and security Camp | 23,90,800 |
| 27/04/2023 | UTR No. ICICR52023052300638561/SBIN0000 082/DIVISIONAL FOREST OFFICER | Hiring good quality Mahindra vehicles | 24,34,550 |
| 04/04/2024 | UTR No. ICICR52024040400571353/SBIN0000 082/DIVISIONAL FOREST OFFICER | Departmental operation | 42,56,220 |
| 13/03/2026 | UTR No. HDFCR52026031381539908 CAMPA | Wildlife Conservation and Management Plan | 1,10,13,814 |
| 20/03/2026 | NEFT Ref No. NBTL200326R1 DFO, Aie Valley | Cost of Plantation of Fruits tree for Golden Langur | 73,03,855 |
| 20/03/2026 | NEFT Ref No. NBTL200326R1 DFO, Aie Valley | 10 Nos JFMC for 5 years | 4,65,25,000 |

In view of the above, you are requested to process the compliance report for issuance of the final approval from the competent authority.

Thanking You,

Nangalbibra-Bongaigaon Transmission Ltd

(Authorized Signatory)
Narottam Chakraborty
Head- Forest & Wildlife



Copy to:

1. The Chief Conservator of Forests and the Nodal Officer (FC Act), Assam, Guwahati for kind information please.

Encl: Pointwise compliance report along with the enclosures.

NANGALBIBRA-BONGAIGAON TRANSMISSION LIMITED

Project Office: Sambriddhi Complex 2nd floor, Pancharatna Road,
Goalpara, Assam.

**COMPLIANCE REPORT**

Pointwise compliance of the in-principle approval No. 3-AS B157/2023-GHY/3649-50, dated 28.02.2023 of the MoEF&CC, IRO Guwahati, for the diversion of 61.6 ha of forest land for construction of 400 kV D/C Bongaigaon to Nangalbibra Transmission line under Haltugaon, Aie Valley, and Goalpara Forest divisions.

A. Conditions need to be complied with prior handing over of forest- land by the State Forest Department:

| Sl. No. | Conditions as per In-Principle approval vide F.No. 3-AS B 157/2023-GHY/3649-50 | Compliance |
|---------|--|---|
| 1 | The User Agency shall transfer, the Net Present Value (NPV) of the forest land being diverted under this proposal as per the orders of the Hon'ble Supreme Court of India dated 28/03/2008, 24/04/2008 and 09/05/2008 in Writ petition (Civil) No. 202/1995 and as per guidelines issued by the Ministry vide letters No. 5-3/2007- FC, dated 05.02.2009 and File No. 5-3/2011FC(Vol-I), dated 21.03.2022. The requisite funds shall be transferred through online portal into CAMPA account of the State concerned. | <p>Aie Valley Forest Division- The NPV amounting Rs. 8,61,039/- has been deposited in CAMPA account vide UTR No: ICICR52023041000244178 /UBIN099 6335/ASSAM CAMP A, dated 10.04.2023 reference to letter No. A/AVD /400KV/718-20, dated 13.03.2023 of the Divisional Forest Officer, Aie Valley forest division.</p> <p>Haltugaon Forest Division- The NPV amounting Rs. 2,75,65,387.30/- has been deposited in CAMP A account vide UTR No: ICICR52023041000244178/UBIN0996335/ASSAM CAMP A, dated 10.04.2023 reference to letter No. B/HFD/LD/NBTL/3653, dated 04.03.2023 of the Divisional Forest Officer, Haltugaon Forest Division</p> <p>Goalpara Forest Division- The NPV amounting Rs. 4,66,27,225/- has been deposited in CAMP A account vide UTR No: ICICR52023041000244178/UBIN0996335/ASSAM CAMP A, dated 10.04.2023 reference to letter No. B/GLP/ DFO(T) /FCA /Diversion proposal/Sterlite Power/1402, dated 13.03.2023 of the Divisional Forest Officer, Goalpara Forest Division.</p> <p>Online payment confirmation is enclosed as Annexure-I.</p> |
| 2 | The User agency shall transfer the cost of raising and maintaining the Compensatory Afforestation at the current wage rate in consultation with State Forest Department in the account of CAMP A of the concern state through online portal. The Scheme may include appropriate provision for anticipated cost increase for work scheduled for subsequent years. | <p>Aie Valley Forest Division- The cost of Compensatory Afforestation amounting Rs. 2,72,71,634.34/- has been deposited in CAMP A account vide UTR No: ICICR52023041000244178/UBIN0996335/ASSAM CAMP A, dated 10.04.2023 in reference to letter No. A/AVD/ 400KV/718-20, dated 13.03.2023 of the Divisional Forest Officer, Aie Valley forest division.</p> <p>Haltugaon Forest Division- The cost of Compensatory Afforestation amounting Rs. 33,94,500/- has been deposited in CAMP A account vide UTR No: ICICR52023041000244178/UBIN0996335/ASSAM CAMP A, dated 10.04.2023 in reference to letter No. B/HFD/LD/NBTL/3653, dated 04.03.2023 of the Divisional Forest Officer, Haltugaon Forest Division.</p> <p>Goalpara Forest Division- The cost of Compensatory Afforestation amounting Rs. 6,55,60,057/- has been deposited in CAMP A account vide UTR No. ICICR52023041000244178/UBIN0996335/ASSAMCAMP A, dated 10.04.2023 in reference to letter No.B/GLP/DFO(T) /FCA/Diversion Proposal/Sterlite Power/1402, dated 13.03.2023 of the Divisional Forest Officer, Goalpara Forest Division.</p> <p>Online payment confirmation is enclosed as Annexure-I.</p> |

NANGALBIBRA-BONGAIGAON TRANSMISSION LIMITED

Project Office: Sambriddhi Complex 2nd floor, Pancharatna Road,
Goalpara, Assam.



| | | |
|---|---|--|
| 3 | All the funds received from the user agency (CA and dwarf plantation cost, NPV etc.) under the project shall be transferred/deposited to compensatory Afforestation Fund of Assam State managed by the Ad-hoc CAMPA only through e-portal (https://parivesh.nic.in/). Amount deposited through other mode will not be accepted as compliance of Stage-I clearance. | The total amount of Rs. 191845839/- has been deposited in CAMPA account vide UTR No: ICICR52023041000244178/UBIN0996335/ASS AMCAMPA, dated 10.04.2023 in reference to the demand note of concerned Divisional Forest Officers, Assam. Online payment confirmation is enclosed as Annexure-I . |
| 4 | The KML files of the area to be diverted, the CA areas, the proposed SMC work, the proposed Catchment Area Treatment area and the WLMP area shall be uploaded on the e-Green watch portal with all requisite details before issuing working permission towards linear projects or submitting compliance report for seeking Stage-II approval, as the case may be. | Noted and shall be ensured. |
| 5 | The boundary of the diverted forest land shall be suitably demarcated on ground at the project cost, as per the direction of the concerned Divisional Forest Officer | <p>Aie Valley Forest Division- The boundary of the diverted forest land has been demarcated on ground at project cost by forest department. The amount of Rs. 7,69,850/- has been deposited in this regard at ICICI bank account no. 070805000767 as directed by the DFO, Aie Valley vide letter no. B/AVD/400KV/2156, dated 06/06/2023.</p> <p>Haltugaon Forest Division- The cost of Rs. 10,10,000/- for departmental operation of trees & boundary pillars, has been deposited, as directed by DFO, Haltugaon vide letter No.B/HFD/LD/NBTL/430, dated 07.05.2023.</p> <p>Goalpara Forest Division- The cost of Rs. 69,49,246/- for Departmental operation of trees & boundary pillars, has been deposited, as directed by DFO, Goalpara vide Letter No. B/GLP/DFO(T)/Diversion Proposal/Sterlite Power/2021, dated 17.04.2023.</p> <p>Photographs are enclosed as Appendix -I</p> |
| 6 | The user agency shall deposit 2% of the total project cost for Human Elephant Conflict mitigation and wildlife conservation purposes and the amount shall be deposited into account of CAMPA. | Reference to the demand letter of the PCCF Wildlife and Chief Wildlife Warden, Assam vide No. WL/FG/Proposal/Bongaigaon-Nangalbira Trans line, dated 23.05.2025 the cost for Human Elephant Conflict mitigation and wildlife conservation purposes an amount of Rs.1,10,13,814/- (One Crore Ten Lakhs Thirteen Thousand Eight Hundred and Fourteen only) has been deposited in Ad-hoc CAMPA Account vide UTR No-HDFCR52026031381539908, dated 13.03.2026. The copy of above demand letter and payment details are enclosed as Annexure-I A . |
| 7 | The State Govt shall ensure that under no circumstances, implementation of such mitigation measures envisaged in Human Elephant/ Wildlife Conflict mitigation and wildlife conservation plan should be delayed beyond a period of 2 years to ensure commencement of rejuvenation of ecosystem services lost from the forest area allowed for non- forestry use of forest land at the earliest possible time | Noted. |
| 8 | The State Govt shall submit Human Elephant/wildlife Conflict mitigation and wildlife conservation plan approved by | As per demand letter received from the PCCF Wildlife and Chief Wildlife Warden, Assam vide No. WL/FG/Proposal/Bongaigaon-Nangalbira Trans line, dated 23.05.2025 and demand letter of the |

NANGALBIBRA-BONGAIGAON TRANSMISSION LIMITED

Project Office: Sambriddhi Complex 2nd floor, Pancharatna Road,
Goalpara, Assam.



| | | |
|----|---|--|
| | Chief Wildlife Warden, Govt. of Assam along with detail cost of its implementation. | DFO, Aie Valley Division, dated 08.07.2025 amount of Rs. 1,10,13,814/- has been deposited in Ad-hoc CAMPA Account vide UTR No- HDFCR52026031381539908, dated 13.03.2026 and Rs. 5,38,28,855/- has been deposited to the bank account of the DFO, Aie Valley Division, through NEFT vide Ref No. NBTL.200326R1 dated 20.03.2026. |
| 9 | <p>The State Govt. shall ensure to comply strictly to the following recommendation of the CWLW, Govt. of Assam: -</p> <p>a. Ground clearance shall be minimum of 15 m as proposed by the UA.</p> <p>b. Three-layer protection measures will be adopted to ensure complete safety and minimum interference with fauna. The measures include barbed fencing of tower area, Special tower design having soft material anti-climbing guards & anti-climbing canopy which will restrict any arboreal animals from climbing on towers.</p> <p>c. User Agency shall prepare and submit WL Management Plans suggested by Forest & WL Department.</p> <p>d. The User agency shall do plantation of fruit trees especially for Golden Langur in and around the Golden Langur habitat area through forest department.</p> <p>e. The user agency shall provide fund and support 10 Nos. of JFMCs for five years in and around Bhairab RF and other nearby forest which are habitat for Golden Langur for taking up Entry point Activity, livelihood activities, ecotourism facilities and capacity building for local youth.</p> <p>f. Felling of trees will be restored only at proposed tower locations and other areas shall be avoided.</p> | <p>All the mentioned conditions will be complied with.</p> <p>a. Ground clearance has been maintained minimum of 15 m along the route in Bhairab RF.</p> <p>b. Three-layer protection measures have been adopted at all the towers in Bhairab RF. Photographs enclosed as Appendix II.</p> <p>c. Reference to the demand letter of the PCCF Wildlife and Chief Wildlife Warden, Assam vide No. WL/FG/Proposal/Bongaigaon-Nangalbira Trans line, dated 23.05.2025 the cost for Human Elephant Conflict mitigation and wildlife conservation purposes an amount of Rs. 1,10,13,814/- (One Crore Ten Lakhs Thirteen Thousand Eight Hundred and Fourteen only) has been deposited in Ad-hoc CAMPA Account vide UTR No- HDFCR52026031381539908, dated 13.03.2026. The copy of above demand letter and payment details are enclosed as Annexure-I A.</p> <p>d. The cost of plantation of fruit trees especially for Golden Langur in and around the Golden Langur habitat area amounting to Rs. 73,03,855/- (Rs. Seventy Three Lakhs Three Thousand and Eight Hundred and Fifty Five only) has been deposited to the bank account of the DFO, Aie Valley Division, Bongaigaon through NEFT vide Ref No. NBTL.200326R1, dated 20.03.2026 against demand letter raised from the DFO, Aie Valley Division, Bongaigaon, dated 08.07.2025. The copy of above demand letter and payment details are enclosed as Annexure -I A.</p> <p>e. The cost of supporting 10 Nos of JFMCs for five years in and around Bhairab RF and other nearby forest amounting to Rs. 4,65,25,000/- (Rs. Four Crore Sixty-Five Lakhs and Twenty Five Thousand only) has been deposited to the bank account of the DFO, Aie Valley Division, Bongaigaon through NEFT vide Ref No. NBTL.200326R1, dated 20.03.2026 against demand letter raised from the DFO, Aie Valley Division, Bongaigaon, dated 08.07.2025. The copy of above demand letter and payment details are enclosed as Annexure -I A.</p> <p>f. Felling of trees have been restricted at the tower locations and bare minimum in the corridor to maintain safe electrical clearance as per Indian standard.</p> |
| 10 | The user agency shall explore the possibility of successful translocation of maximum number of trees identified to be felled shall be explored and any tree felling shall be done only when it is unavoidable and that too under strict supervision of the State Forest department. | Translocation of trees have been explored, and unavoidable trees were only felled by the forest department. |

Amity

NANGALBIBRA-BONGAIGAON TRANSMISSION LIMITED

Project Office: Sambriddhi Complex 2nd floor, Pancharatna Road,
Goalpara, Assam.



| | | |
|----|---|--|
| 11 | The charges for felling, logging and transportation of project affected trees should be collected from the User Agency at the rates approved by the State Govt and deposited with the DFO concerned for utilization immediately following the diversion of forest land. | <p>Aie Valley Forest Division- The cost of Departmental operation of trees has been deposited in the ICICI bank account no. 070805000767 as directed by the DFO, Aie Valley vide letter No. B/AVD/400KV/2156, dated 06/06/2023.</p> <p>Haltugaon Forest Division- The cost of Rs. 10,10,000/- for departmental operation of trees & boundary pillars, has been deposited, as directed by the DFO, Haltugaon vide letter No.B/HFD/LD/NBTL/430, dated 07.05.2023.</p> <p>Goalpara Forest Division- The cost of Rs. 69,49,246/- for Departmental operation of trees & boundary pillars, has been deposited, as directed by the DFO, Goalpara vide letter No. B/GLP/DFO(T)/Diversion Proposal/Sterlite Power/2021, dated 17.04.2023.</p> |
| 12 | The expenditure like boundary walls, stone pillars, demarcation charges, cost of damage of trees the funds on these accounts should be deposited with the DFO concerned. | <p>Aie Valley Forest Division- The cost of boundary pillars and Departmental operation of trees has been deposited in the ICICI bank account no. 070805000767 as directed by the DFO, Aie Valley vide Letter No. B/AVD/400KV/2156, dated 06.06.23 & B/AVD/400KV/BNG to Nagalbibra/2024/3364, dated 08.08.24.</p> <p>Haltugaon Forest Division- The cost of Rs. 10,10,000/- for departmental operation of trees & boundary pillars, has been deposited, as directed by the DFO, Haltugaon vide letter No.B/HFD/LD/NBTL/430, dated 07.05.2023.</p> <p>Goalpara Forest Division- The cost of Rs. 69,49,246/- for Departmental operation of trees & boundary pillars, has been deposited, as directed by the DFO, Goalpara vide letter No. B/GLP/DFO(T)/Diversion Proposal/Sterlite Power/2021, dated 17.04.2023.</p> |
| 13 | The User Agency shall restrict the felling of trees to minimum number in the diverted forest land and the trees will be felled under the strict supervision of the State Forest Department, and the cost of felling of trees has been deposited to the state Forest Department. | Unavoidable trees were only felled by Forest Department & cost of felling has been deposited as per demand of all the concerned DFO. |
| 14 | The complete compliance of the FRA, 2006 shall be ensured by way of prescribed certificate from the concerned District Collector. | The complete compliance of the FRA, 2006 have been completed in all three districts. FRA certificates enclosed as Annexure-III . |
| 15 | Violation of any of these conditions will amount to violation of Forest (conservation) Act, 1980 and action would be taken as prescribed in para 1.21 of chapter I of the Handbook of comprehensive guidelines of Forest (conservation) Act, 1980 as issued by this Ministry's letter No. 5-2/2017-Fc dated 28.03.2019. | Agreed. Undertaking in this regard is enclosed as Annexure-II . |
| 16 | The User Agency in consultation with the State Forest Department prepare a detailed scheme for creation and maintenance of plantation of dwarf species (preferably medicinal plants) in right of way under the transmission line for execution of the said scheme to the State Forest Department. | Aie Valley Forest Division- The detailed scheme for creation and maintenance of plantation of dwarf species in right of way under the transmission line has been prepared. The cost of Dwarf Plantation Rs. 48,22,321/- has been deposited in CAMPA account vide UTR No: ICICR52023041000244178/UBIN099633/ASSAM CAMPA, dated 10.04.2023 in reference to letter No. A/AVD/400KV/718-20, dated 13.03.2023 of the Divisional Forest Officer, Aie Valley forest division. |

NANGALBIBRA-BONGAIGAON TRANSMISSION LIMITED

Project Office: Sambriddhi Complex 2nd floor, Pancharatna Road, Goalpara, Assam.



| | | |
|----|--|---|
| | | <p>Haltugaon Forest Division- The detailed scheme for creation and maintenance of plantation of dwarf species in right of way under the transmission line has been prepared. The cost for Dwarf Plantation Rs. 16,54,000/- has been deposited in CAMPA account vide UTR No: ICICR52023041000244178/UBIN0996335/ASSAM CAMPA, dated 10.04.2023 in reference to letter No. B/HFD/LD/NBTL/3653, dated 04.03.2023 of the Divisional Forest Officer, Haltugaon Forest Division.</p> <p>Goalpara Forest Division- The detailed scheme for creation and maintenance of plantation of dwarf species in right of way under the transmission line has been prepared. The cost for Dwarf Plantation Rs. 1,40,89,175/- has been deposited in CAMPA account vide UTR No: ICICR52023041000244178/UBIN099633/ASSAM CAMPA, dated 10.04.2023 in reference to letter No.B/GLP/DFO(T)/FCA/Diversion Proposal/ Sterlite Power/1402, dated 13.03.2023 of the Divisional Forest Officer, Goalpara Forest Division.</p> <p>Online payment confirmation enclosed as Annexure-I.</p> |
| 17 | The compliance report shall be uploaded on -e-portal (https://parivesh.nic.in) | Noted and shall be complied. |

B. Conditions need to be strictly complied on field after handing over of forest- land to the user agency by the State Forest Department but the compliance in form of undertaking shall be submitted prior to Stage-II approval:

| Sl. No. | Conditions as per In- Principle approval vide F.No. 3-AS B 157/2023-GHY/3649-50 | Compliance |
|---------|---|---|
| 1 | Legal status of forest land proposed for diversion shall remain unchanged. | Agreed. Undertaking in this regard is enclosed as Annexure-II . |
| 2 | The compensatory Afforestation shall be taken up on doubled the degraded forest land of 125.35 ha which has been identified in three different patches i.e. 1.35 ha in Nayekgaon Range, Haltugaon Forest Division in Kokrajhar district; 84 ha in Lakhipur Range in Nalbari RF (10 ha), Central Range, Krishnai, Zengrazanga (39 ha), Central Krishnai Zengrazanga (25 ha), Rongjuli Dolngdo Reserve Forest (10 ha) in Goalpara District; and 40 ha in Abhayapuri Range, Aie vally Forest Division in Bongaigaon District of Assam within three years from the date of Stage-II clearance and maintained thereafter by the State Forest Department at the cost of the User Agency. As far as possible, a mixture of local indigenous species shall be planted, and monoculture of any species may be avoided. The CA will be maintained for 10 years. | Cost for raising Compensatory Afforestation for all the locations in three Forest Divisions has been deposited in CAMPA account vide UTR No: ICICR52023041000244178/UBIN0996335/ASSAM CAMPA, dated 10.04.2023. Online payment confirmation enclosed as Annexure-I |
| 3 | At the time of payment of the Net Present Value (NPV) at the time of prevailing rate, the User Agency shall furnish an undertaking to pay the additional amount of NPV, if so determined, as per final decision of the Hon'ble Supreme Court of India | Agreed. Undertaking in this regard is enclosed as Annexure-II . |
| 4 | The User Agency shall obtain the Environment Clearance as per the provisions of Environment (Protection) Act, 1986, if required (NA). | Not applicable for transmission line projects. |
| 5 | No labour camp shall be established on the forest land and fuels preferably the alternated fuel to labourers and the staff working at the site shall be provided so as to avoid any damage and pressure on the nearby forest areas. | Agreed. Undertaking in this regard is enclosed as Annexure-II . |
| 6 | The forest land proposed to be diverted shall under no circumstances be transferred to any other agencies. | Agreed. Undertaking in this regard is enclosed as Annexure-II . |

Anty

NANGALBIBRA-BONGAIGAON TRANSMISSION LIMITED

Project Office: Sambriddhi Complex 2nd floor, Pancharatna Road,
Goalpara, Assam.



| | | |
|----|--|--|
| | department, or person without prior approval of the Govt. of India. | |
| 7 | No damage to the flora and fauna of the adjoining areas shall be caused. | Shall be complied. Undertaking in this regard is enclosed as Annexure-II . |
| 8 | The layout of the proposal shall not be changed without prior approval of the central Govt. | Agreed. Undertaking in this regard is enclosed as Annexure-II . |
| 9 | The concerned Divisional Forest Officer will monitor and take necessary mitigative measures to ensure that there is no adverse impact on the forests in the surrounding Area. | Noted. |
| 10 | The User Agency at its cost shall provide bird deflectors which are to be fixed on the upper conductor of transmission line at suitable interval to avoid bird hits. | The bird deflectors have been installed on the upper conductor of transmission line at suitable interval. Photographs enclosed as Appendix III . |
| 11 | The User Agency shall comply all the provision of all Acts, Rules, Regulations, Guidelines, Hon'ble Court Order(s) and NGT Order(s) pertaining to this project, if any, for the time being in force as applicable to the project | Agreed. Undertaking in this regard is enclosed as Annexure-II . |
| 12 | The User Agency shall comply with the guidelines for laying transmission through forest areas issued by Ministry vide letter No. 7-25/2012-FC, dated 5/05/2014 & 19/11/2014. | Agreed. Undertaking in this regard is enclosed as Annexure-II . |
| 13 | No additional or new path will be constructed inside the forest area for transportation of construction materials for execution of the project work. | Agreed. Undertaking in this regard is enclosed as Annexure-II . |
| 14 | The period of diversion under this approval shall be co-terminus with the period of lease to be granted in favour of the user agency or the project life, whichever is less. | Agreed. |
| 15 | The forest land shall not be used for any purpose other than that specified in the project proposal. | Agreed. Undertaking in this regard is enclosed as Annexure-II . |
| 16 | As per Ministry's letter no 11-30/96-FC (Pt) dt. 14.9.2001 if the compliance of stipulated conditions is awaited from the State Govt for more than 5 (five) years, the in-principle approval would be summarily revoked considering that the user agency is no longer interested in the project. | Agreed. |
| 17 | Any other conditions that the Integrated Regional Office, Guwahati, MoEFCC may be stipulated from time to time in the interest of conservation protection and development of Forest & Wildlife | Agreed. |

Date: 23/03/2026

Signature:

Name: Narottam Chakraborty

Designation: Head- Forest & Wildlife

Nagalbibra-Bongaigaon Transmission Ltd.

Address of Agency:

Resonia Limited,

5th Floor, RMZ Infinity, Plot No 15

Phase IV, Sec-18, Gurugram, Haryana, 122015.



PARIVESH
परिवेश

Ministry of Environment, Forest and Climate Change
Government of India

"Pro Active and Responsive facilitation by Interactive, Virtuous and Environmental Singlewindow Hub"



My Account ▾ My Proposals Environment Clearance ▾ Only CRZ Clearance ▾ My Proposals Forest Clearance ▾ My Proposals Wildlife Clearance ▾ Help ▾

3:07:26 PM

Online payment history made by User Agency under CAMPA

Help

| Sno. | Proposal Detail | Application_No | Application No (New) | Date of IN-PRINCIPLE | Amount to be Paid/Amount Paid (in Rs.) | Payment Status | Payment Detail | Demand Letter |
|------|--|--------------------|----------------------|----------------------|--|--|--|------------------------------------|
| 1 | PPAS TRANS:152968/2022 Construction of 400 KV DC Bongaigaon Nangalbibra Transmission Line | TRANS1529682022966 | 34152968966 | 28 Feb 2023 | CA: 96226192/- Addl CA : 0/- PCA: 0/- CAT : 0/- Safety Zone: 0/- Addl PA : 0/- NPV: 75053651/- Dwarf Species (Medicinal) Plantation : 20565996/- Other Charges1 : 0/- Other Charges2 : 0/- Other Charges3 : 0/- Total : 191845639/- |  Paid | Fund Demand Verified by :15 Mar 2023 Nodal Officer On Bank Name :Union Bank Of India Mode of Payment :NEFT/RTGS (Challan) Challan Generated On :25 Mar 2023 Transaction Date :11 Apr 2023 | Demand Letter Generated Challan |









NANGALBIBRA-BONGAIGAON TRANSMISSION LIMITED

DLF Cyber Park Tower-B, 9th Floor, Udyog Vihar Phase-III,
Sector-20, Gurugram-122008, Haryana India +91 0124 4562 000



ANNEXURE- I A

PAYMENT DETAILS

| Date | UTR No | Payment Description | Payment Head | Transaction Amount |
|------------|-----------------------------------|---|-------------------------------------|--------------------|
| 13/03/2026 | UTR No. HDFCR52026031381539908 | Wildlife Conservation and Management Plan | CAMPA Assam A/C No. 150617299 | 1,10,13,814 |
| 20/03/2026 | NEFT Ref No. NBTL200326R1 | Cost of Plantation of Fruits tree for Golden Langur | A/C No. 070805000767 | 73,03,855 |
| 20/03/2026 | NEFT Ref No. NBTL200326R1 | 10 Nos JFMC for 5 years | A/C No. 070805000767 | 4,65,25,000 |



(Authorized Signatory)

Narottam Chakraborty
Head- Forest & Wildlife
Nangalbibra Bongaigaon Transmission Ltd.



GOVERNMENT OF ASSAM
OFFICE OF THE PRINCIPAL CHIEF CONSERVATOR OF FORESTS, WILDLIFE AND
CHIEF WILDLIFE WARDEN, ASSAM

Email ID: pccf.wl.assam@gmail.com

No. WL/FG/Proposal/Bongaigaon-Nangalbibra Trans line

Date: 23.05.2025

To,

The Chief Manger,
Nangalbibra-Bongaigaon Transmission Ltd.,
2nd Floor, Samriddhi Complex, New Market,
Pancharatna Road, Goalpara, Assam-783101.

Sub: Deposition of 2% project cost for Human Elephant/Wildlife Conflict Mitigation & Wildlife Conservation purpose against proposal for "diversion of 61.6 Ha. of forest land for construction of 400 kV D/C Bongaigaon to Nangalbira Transmission Line in Sathbandi RF, Bhairab RF, Pancharatna RF, Sagunbari RF, Zangrazangsa RF, Bogulmari PRF & Rakshashini PRF under haltugaon Division (area-0.66 Ha), Aie Valley Division (area-19.187 Ha) & Goalpara Division (41.747 Ha) by Nangalbibra-Bongaigaon Transmission Ltd".

Ref: 1. This office letter No. WL/FG/proposal/Bongaigaon-Nangalbibra Trans line, dated 07.06.2023.
2. Your office letter No. NBTL/FOREST/2025-26/01, dated 30.04.2025.

Sir,

Pursuant to the MoEF & CC, Govt of India's F.No. 3 AS B 157/2023-GHY/3649-50, dated 20.02.2023 granting "In Principle Approval/Stage-I" for the above-mentioned proposal and with reference to the subject and letters cited above, it is requested to deposit 2% of the proportionate project cost to the account of CAMPA, as estimated below:

- (a) Total area of the project both in the state of Assam & Meghalaya = 563.772 Ha.
- (b) Total area of project in the state of Meghalaya (non-forest + forest) = 243.496 Ha.
- (c) Total area of the project in the state of Assam (non-forest + forest) = 320.276 Ha.
- (d) Area of forest land proposed for diversion in the state of Assam = 61.6 Ha.
- (e) Proportionate cost of the project in the state of Assam = $320.276/563.772 \times Rs\ 504,00,00,000 = Rs\ 286,31,98,314/-$
- (f) **2% proportionate project cost** = $61.6/320.276 \times Rs.\ 286,31,98,314 \times 2\%$
= Rs 1,10,13,814/-

In view of the above, it is requested to deposit an above-mentioned amount of **Rs 1,10,13,814/- (one crore ten lakhs thirteen thousand eight hundred fourteen only)** for preparation and implementation of Human Elephant/Wildlife Conflict Mitigation & Wildlife Conservation and Management Plan with special emphasis on Golden Langur, in the account of CAMPA.

This is for your kind information and necessary action.

Yours faithfully,



(Dr. Vinay Gupta, IFS)

Principal Chief Conservator of Forests,
Wildlife & Chief Wildlife Warden, Assam.

Copy for information and necessary action to.

1. CCF & Nodal Officer (FC Act), Assam, O/o the PCCF & HoFF, Assam. This has a reference to this office letter No. WL/FG/Proposal/Bongaigaon-Nangalbibra Trans line, dated 26.12.2024 and your letter No. FG.27/FCA/Proposal/Nangalbibra-Bongaigaon Transmission Ltd., dated 18.02.2025.
2. DFO, Goalpara Division, Goalpara, Aie Valley Division, Bongaigaon & Haltugaon Division, Kokrajhar.



Principal Chief Conservator of Forests,
Wildlife & Chief Wildlife Warden, Assam.

Copy for information to Principal Chief Conservator of Forests & Head of Forest Force, Assam, Panjabari, Guwahati-37.



Principal Chief Conservator of Forests,
Wildlife & Chief Wildlife Warden, Assam.



GOVT. OF ASSAM
OFFICE OF THE DIVISIONAL FOREST OFFICER:::AIE VALLEY DIVISION
BONGAIGAON.

E-mail- dfo.t.aievalley@gmail.com

Date: 08/07/25

No. B/AVD/Sterlite/400kv/2025/ 3583

To,

The Chief Manager
Sterlite Power Transmission Limited
2nd Floor, Samriddhi Complex
New Market, Pancharatna Road
Goalpara, Assam-783101

Sub: Demand note for submission of Human Elephant/Wildlife Conflict Mitigation and Wildlife Conservation Plan against the project "Construction of 400 KV DC Nangalbibra-Bongaigaon Transmission Line.

Ref: MoEF & CC Regional Office, Guwahati vide F.No.3 AS B 157/2023 GHY/3649-50, dt. 28.02.2023 &

Your letter No. NBT/FOREST/2025-26/02, dtd. 06.05.2025

Sir,

With reference to the subject cited above, you are requested to deposit the cost of plantation of fruit bearing species for Golden Langur & fund for 10(ten) nos. J.F.M.C. for implementing different activities within five years around the Bhairab Hill R.F. as per condition no. A.(9)(d) &(e) of the "In Principle Approval/Stage-I" clearance accorded by the Central Government vide Regional Office, Shillong, Ministry of Environment, Forest & Climate Change letter no. F.No. 3 AS B 157/2023 GHY/3649-50, dt. 28.02.2023 against the project "Construction of 400 KV DC Nangalbibra-Bongaigaon Transmission Line. The amount should be deposited in the following Bank Account and the details break up of amount shown below.

- | | | |
|------|---|--------------------------|
| (i) | Cost of raising plantation for fruit bearing species for Golden Langur | Rs. 73,03,855/- |
| (ii) | Cost of 10(ten) nos. J.F.M.C. for different schemes for five years around the Bhairab Hill R.F. | Rs. 4,65,25,000/- |
| | Total= | Rs. 5,38,28,855/- |

In words: (Rupees Five Crore Thirty Eight Lakh Twenty Eight Thousand Eight hundred Fifty Five) only

Bank Details:

Name of A/C holder : Divisional Forest Officer,
Aie Valley Division, Bongaigaon
Name of Bank : ICICI Bank, Bongaigaon Branch
Account No. : 70805000767
IFSC : ICIC0000708

This is for your kind information and necessary action.

Yours faithfully

Haliw
08/07/25
Divisional Forest Officer
Aie Valley Division
Bongaigaon

Date: 08/07/25

No. A/AVD/Sterlite/400kv/2025/ 3583-85

Copy to:

1. The Principal Chief Conservator of Forests, Wildlife & Chief Wildlife Warden, Assam, Panjabari, Guwahati-37 for favour of his kind information and necessary action.
2. The Chief Conservator of Forests & Nodal Officer (F.C. Act), Assam the Conservator of Forests, Lower Assam Social Forestry Circle, Bongaigaon for favour of his kind information.
3. The Conservator of Forests, Lower Assam Social Forestry Circle, Bongaigaon for favour of his kind information.

SP

Haliw
08/07/25
Divisional Forest Officer
Aie Valley Division
Bongaigaon

Norms for 20 ha Artificial Regeneration (AR) plantation with fruit bearing trees

Area (ha) = 20
 Spacing (m x m) = 2 X 2
 Wage Rate as per latest CAMPA norms = Rs. 353
 Total quantity of saplings to be planted = 50,000 nos.
 Total quantity of saplings to be raised/purchased = 82,500 nos.

| Sl no | Particulars of work | Units | Qty/Ha | Total Qty | Rate/Unit | Amount (Rs.) |
|----------|--|-------|--------|-----------|-----------|------------------|
| 7 | 3RD YEAR MAINTENANCE | | | | | |
| | 4 weeding, mulching and fire protection works @ 20 DLs/ha weeding | DLs | 80 | 1600 | 353 | 5,64,800 |
| | 15% vacancy filling by 2 years old seedling from site nursery/CAMPA nursery | DLs | 23 | 460 | 353 | 1,62,380 |
| | Maintenance and protection of field nursery and 1 no watch and ward for the plantation area for 365 days | DLs | 1 | 365 | 353 | 1,28,845 |
| | Maintenance of Camp Hut, implement, upkeep of plantation signboard, documentation, upkeep of records etc | LS | | | | 5000 |
| | Contingency | LS | | | | 15,000 |
| | Sub Total | | | | | 8,76,025 |
| 8 | 4TH YEAR MAINTENANCE | | | | | |
| | 4 weeding, mulching and fire protection works @ 15 DLs/ha weeding | DLs | 60 | 1200 | 353 | 5,64,800 |
| | 10% vacancy filling by 3 years old seedling from site nursery/CAMPA nursery | DLs | 20 | 400 | 353 | 1,41,200 |
| | Maintenance and protection of field nursery and 1 no watch and ward for the plantation area for 365 days | DLs | 1 | 365 | 353 | 1,28,845 |
| | Maintenance of Camp Hut, implement, upkeep of plantation signboard, documentation, upkeep of records etc | LS | | | | 5000 |
| | Contingency | LS | | | | 15,000 |
| | Sub Total | | | | | 8,54,845 |
| 9 | 5TH YEAR MAINTENANCE | | | | | |
| | 3 weeding, climber cutting & other silvicultural works and fire protection works @ 15 DLs/ha | DLs | 45 | 900 | 353 | 3,17,700 |
| | Maintenance and protection of field nursery and 1 no watch and ward for the plantation area for 365 days | DLs | 1 | 365 | 353 | 1,28,845 |
| | Maintenance of Camp Hut, implement, upkeep of plantation signboard, documentation, upkeep of records etc | LS | | | | 5000 |
| | Contingency | LS | | | | 15,000 |
| | Sub Total | | | | | 4,66,545 |
| | GRAND TOTAL | | | | | 73,03,855 |

Approved by

 Conservator of Forests
 Lower Assam Social Forestry Circle
 Bongaigaon

Countersigned by

 Divisional Forest Officer
 Aie Valley Division
 Bongaigaon

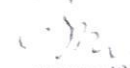

Submitted by

 Forest Range Officer
 Abhavapur Range
 Abhavapur

| | | | | |
|--|---|---|--|--|
| Bond |  | Indian-Non Judicial Stamp Haryana Government |  | Date : 18/03/2026 |
| Certificate No. | G0R2026C574 |  | Stamp Duty Paid : ₹ 101 | |
| GRN No. | 148841143 |  | Penalty : ₹ 0 | |
| Deponent | | | | |
| Name : | Nangal Bibra bongaigaon Transmission ltd | | | |
| H.No/Floor : Na | Sector/Ward : 20 | Landmark : Tower b dif cyber park | | |
| City/Village : Gurugram | District : Gurugram | State : Haryana | | |
| Phone : 95*****48 | | | |  |
| Purpose : FOR SUBMISSION OF COMPLIANCE to be submitted at Concerned office | | | | |

The authenticity of this document can be verified by scanning this QR Code Through smart phone or on the website <https://egrashry.nic.in>

Annexure-II

Undertaking for compliance with the conditions of the in-principle approval No. 3-AS B157/2023-GHY/3649-50, dated 28.02.2023, for the diversion of 61.6 ha of forest land for construction of 400 kV D/C Bongaigaon to Nangalbibra Transmission line under Hattugaon, Aie Valley, and Goalpara Forest divisions:

- 
- 
- 1) As per condition No. 2 A (15) of the IPA we, Nangalbibra-Bongaigaon Transmission Ltd. do hereby undertake that **“no violation of any of the conditions shall be done and accept that violation of any of these conditions will amount to violation of forest conservation Act, 1980.”**
 - 2) As per condition No. 2 B (1) of the IPA we, Nangalbibra-Bongaigaon Transmission Ltd. do hereby undertake that **“Legal status of forest land proposed for diversion shall remain unchanged.”**
 - 3) As per condition No. 2 B (3) of the IPA we, Nangalbibra-Bongaigaon Transmission Ltd. do hereby undertake that **“additional amount of NPV, if so determined, as per final decision of the hon’ble supreme court of India shall be paid by us”.**
 - 4) As per condition No. 2 B (5) of the IPA we, Nangalbibra-Bongaigaon Transmission Ltd. do hereby undertake that, **“no labour camp shall be established on the forest land and fuels preferably the alternated fuel to labourers and the staff working at the site shall be provided so as to avoid any damage and pressure on the nearby forest areas.**

- 5) As per condition No. 2 B (6) of the IPA we, Nangalbibra-Bongaigaon Transmission Ltd. do hereby undertake that **“the forest land proposed to be diverted shall under no circumstances be transferred to any other agencies, department or person without prior approval of Govt. of India”**.
- 6) As per condition No. 2 B (7) of the IPA we, Nangalbibra-Bongaigaon Transmission Ltd. do hereby undertake that **“no damage to the flora and fauna of the adjoining areas shall be caused.”**
- 7) As per condition No. 2 B (8) of the IPA we, Nangalbibra-Bongaigaon Transmission Ltd. do hereby undertake that **“layout of the proposal shall not be changed without the prior approval of the Central Government.”**
- 8) As per condition No. 2 B (11) of the IPA we, Nangalbibra-Bongaigaon Transmission Ltd. do hereby undertake that, **“compliance of all acts, rules, regulations, guidelines, the hon’ble court order(s) and NGT order(s) pertaining to this project, if any, for the time being in force as applicable to the project”**.
- 9) As per condition No. 2 B (12) of the IPA we, Nangalbibra-Bongaigaon Transmission Ltd. do hereby undertake **“to comply with the guidelines for laying transmission lines through forest areas issued by Ministry vide letter No- 7-25/2012/FC dated 05.05.2014 & 19/11/2014”**.
- 10) As per condition No. 2 B (13) of the IPA we, Nangalbibra-Bongaigaon Transmission Ltd. do hereby undertake that, **“no additional or new path will be constructed inside forest area for transportation of construction materials for execution of the project work”**.
- 11) As per condition No. 2 B (15) of the IPA we, Nangalbibra-Bongaigaon Transmission Ltd. do hereby undertake that, **“forest land shall not be used for any purpose other than that specified in the project proposal”**.

Date: 23/03/2026

Place: Goalpara

Signature: 



Name: Narottam Chakraborty
Designation: Head- Forest & Wildlife
Nangalbibra Bongaigaon Transmission Ltd.

Address of Agency:

Resonia Limited,
5th Floor, RMZ Infinity, Plot No 15
Phase IV, Sec-18, Gurugram, Haryana, 122015

FORM-I

(for linear projects)
Government of Assam
Office of the Deputy Commissioner,
Goalpara

No. Rev/1487/2023-REV-GLP/71

Dated : 03rd June, 2023**TO WHOM SO EVER IT MAY CONCERN**

In compliance of the Ministry of Environment and Forests (MoEF), Government of India's letter No.11-9/98-FC(pt.) dated 3rd August, 2009, wherein the MoEF issued guidelines on submission of evidences for having initiated and completed the process of settlement of rights under the Scheduled Tribes and Other Traditional Forest Dwellers (Recognition of Forest Right) Act, 2006 ('FRA', for short) on the forest land proposed to be diverted for non-forest purposes read with MoEF's letter dated 5th February, 2013, wherein MoEF issued certain relaxation in respect of linear projects, it is certified that 41.747 hectares of forest land proposed to be diverted in favour of Sterlite Power for Construction of 400 KV D/C Bongaigaon-Nangalbibra Transmission Line in Goalpara district falls within jurisdiction of Pancharatna Hill RF, Bagulamari PRF, Sagunbahi RF, Rakhyasini PRF and Zangrajangsa RF under Balijana Tehsil.

It is further certified that:

- (a) The complete process for identification and settlement of rights under the FRA has been carried out for the entire.....hectares of forest area proposed for diversion. A copy of records of all consultations and meetings of the Forest Rights Committee (s), Gram Sabha (s), Sub-Division Level Committee (s) and the District Level Committee are enclosed as annexure.....to.....annexure.....(**Not Applicable**)
- (b) The diversion of forest land for facilities managed by the Government as required under section 3 (2) of the FRA have been completed and the Grama Sabhas have given their consent to it; (**Not Applicable**)
- (c) The proposal does not involve recognized right of Primitive Tribal Groups and Pre-agricultural communities.

**Signed by Khanindra
Choudhury**

Date: 03-06-2023 17:27:08

(Shri Khanindra Choudhury, IAS)
Deputy Commissioner,
Goalpara

FORM-I

(for linear projects)
Government of Assam
Office of the Deputy Commissioner,
Goalpara

No. Rev/1487/2023-REV-GLP/71

Dated : 03rd June, 2023TO WHOM SO EVER IT MAY CONCERN

In compliance of the Ministry of Environment and Forests (MoEF), Government of India's letter No.11-9/98-FC(pt.) dated 3rd August, 2009, wherein the MoEF issued guidelines on submission of evidences for having initiated and completed the process of settlement of rights under the Scheduled Tribes and Other Traditional Forest Dwellers (Recognition of Forest Right) Act, 2006 ('FRA', for short) on the forest land proposed to be diverted for non-forest purposes read with MoEF's letter dated 5th February, 2013, wherein MoEF issued certain relaxation in respect of linear projects, it is certified that 41.747 hectares of forest land proposed to be diverted in favour of Sterlite Power for Construction of 400 KV D/C Bongaigaon-Nangalibra Transmission Line in Goalpara district falls within jurisdiction of Pancharatna Hill RF, Bagulamari PRF, Sagunbahi RF, Rakhyasini PRF and Zangrajangsa RF under Balijana Tehsil.

It is further certified that:

- (a) The complete process for identification and settlement of rights under the FRA has been carried out for the entire.....hectares of forest area proposed for diversion. A copy of records of all consultations and meetings of the Forest Rights Committee (s), Gram Sabha (s), Sub-Division Level Committee (s) and the District Level Committee are enclosed as annexure.....to.....annexure.....(**Not Applicable**)
- (b) The diversion of forest land for facilities managed by the Government as required under section 3 (2) of the FRA have been completed and the Grama Sabhas have given their consent to it; (**Not Applicable**)
- (c) The proposal does not involve recognized right of Primitive Tribal Groups and Pre-agricultural communities.

Signed by Khanindra
Choudhury

Date: 03-06-2023 17:27:08

(Shri Khanindra Choudhury, IAS)
Deputy Commissioner,
Goalpara

FORM-1
(For linear project)

GOVERNMENT OF ASSAM
OFFICE OF THE DISTRICT MAGISTRATE: KOKRAJHAR
(MAGISTRACY BRANCH)

No.E-34035/102

Dated, Kokrajhar the 14th November' 2024.

TO WHOMSOEVER IT MAY CONCERN

In compliance of Ministry of Environment and Forest (MoEF), Government of India's No.11-9/98-FC(pt.) dated 3rd August' 2009 wherein the MoEF issued guidelines on submission of evidences for having initiated and completed the process of settlement of rights under the Schedule Tribes and Other Traditional Forest Dwellers (Recognition of Forest Rights) Act, 2006 (FRA, for short on the forest land proposed to be diverted for non-forest purposes read with MoEF's letter dated 5th February 2013 wherein MoEF issued certain relaxation in respect of linear project, it is certified that 0.666 Hectares of forest land proposed to be diverted in favour of Chief Manager, Nangalbibra-Bongaigaon Transmission Limited (name of user agency) for construction of 400KV D/C Bongaigaon Transmission Line (purpose for diversion of forest land) in Kokrajhar district falls within jurisdiction of Satbhendi village (s) under No.2 Satbhendi RF under Nayekgaon Range under DFO, Haltugaon Division in Kokrajhar thesils.

It is further certified that:

(a)The complete process for identification and settlement of rights under the FRA has been carried out for the entire 0.666 hectares of forest area proposed for diversion. A copy of records of all consultations and meetings/NOC of the forest Rights Committee, Gram Sabha, Sub-Division Level Committee, Bodoland Territorial Council (BTC) are enclosed as annexure 1 to V.

(b)The diversion of forest land for facilities managed by the Government as required under section 3(2) of the FRA have been completed and the Gram Sabha, SDLC and BTC have given their consent to it.

(c)The proposal does not involve recognized rights of Primitive Tribal groups and Pre agriculture communities.

Signed by

Masanda Magdalin Perlin
District Magistrate,

Date: 14/11/2024 17:21:00
District Magistrate
Kokrajhar

Forest Land Boundary Demarcation by Concrete Pillers

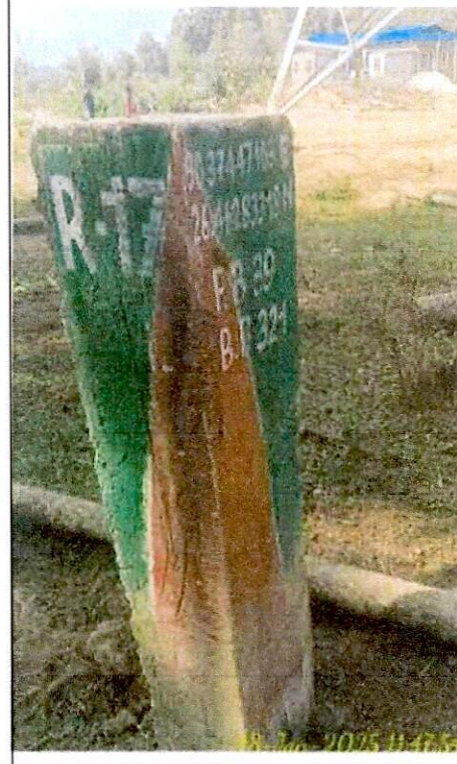

Three Layer Protection Measures implemented on Towers at Bhairab Forest to Restrict Climbing of Arboreal Animals

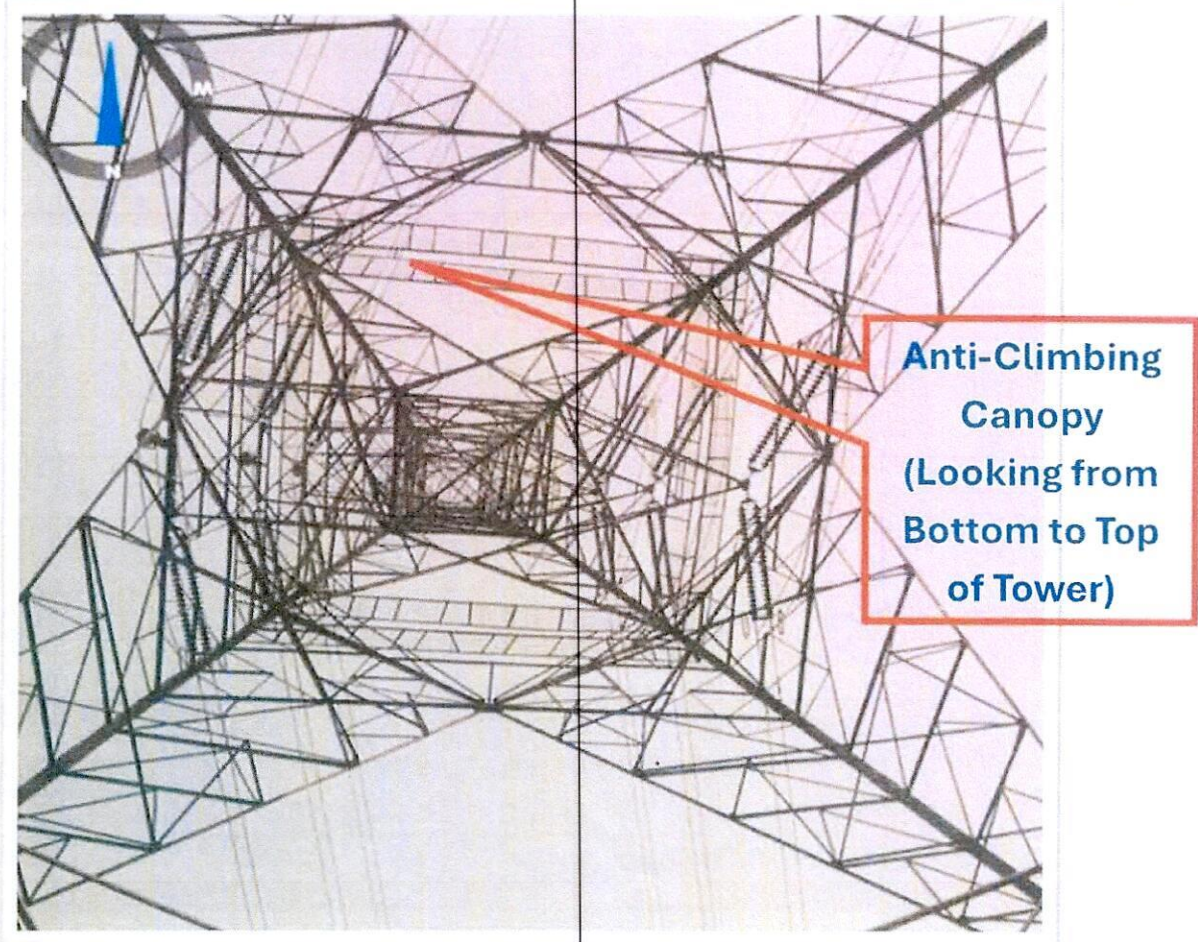
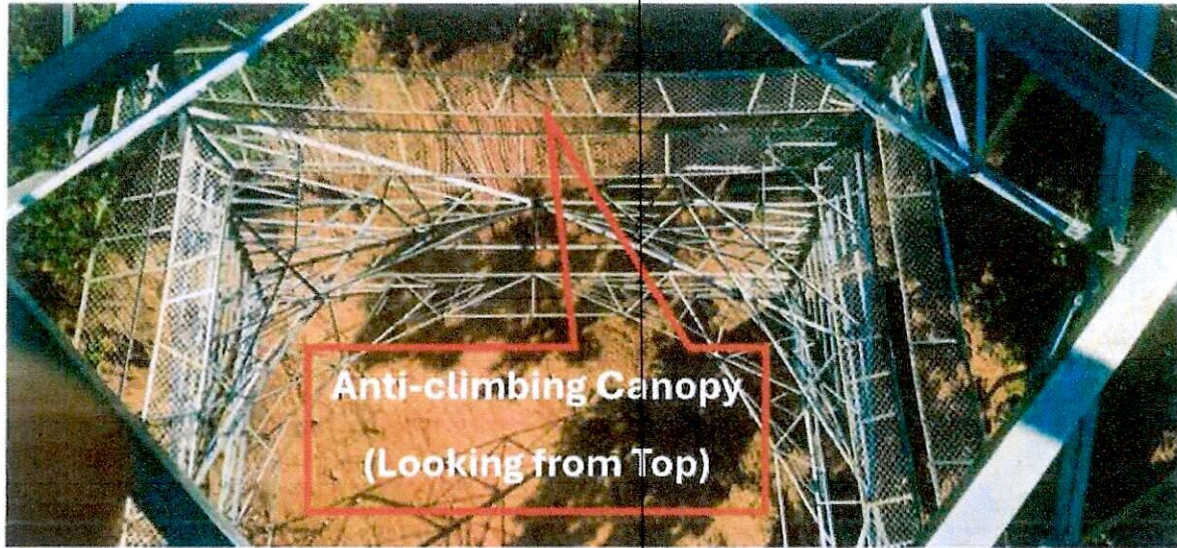

Quinty

Three Layer Protection Measures implemented on Towers at Bhairab Forest to Restrict Climbing of Arboreal Animals

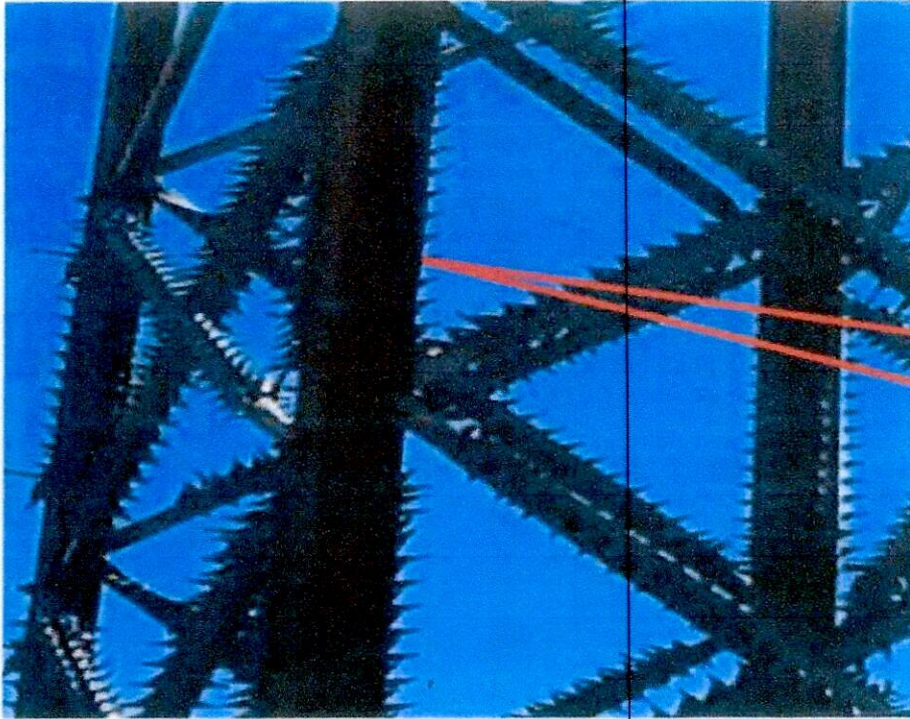

**Anti-Climbing
Guards**

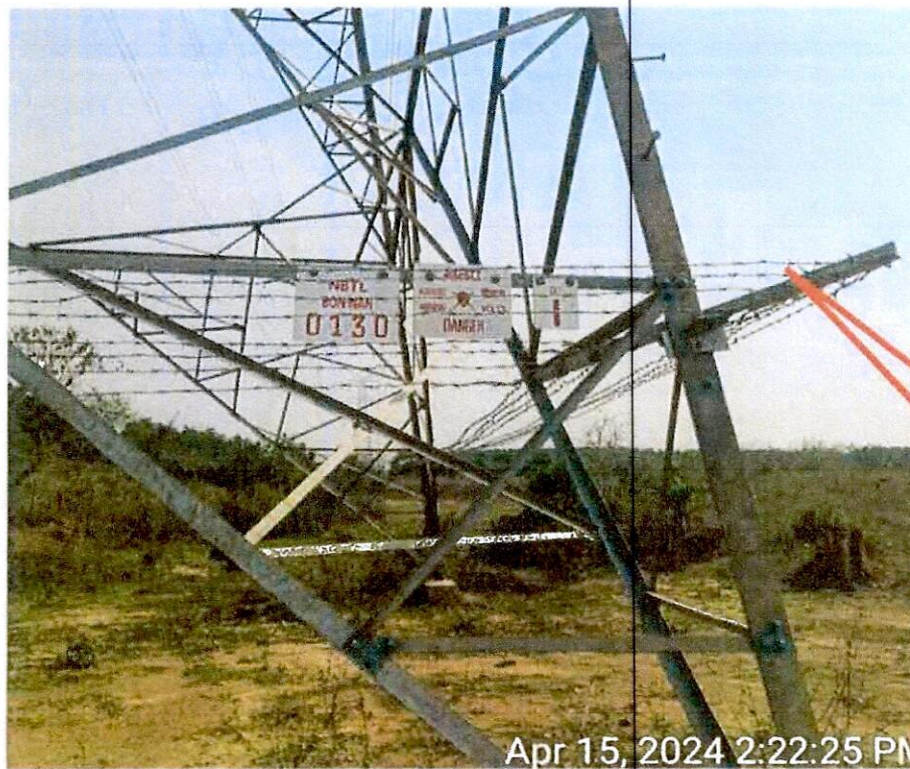

**Anti-Climbing
Device with
Barbed wire
Fencing**

Bird Deflectors Installed on Upper Conductor of Transmission Line in Forest Land.

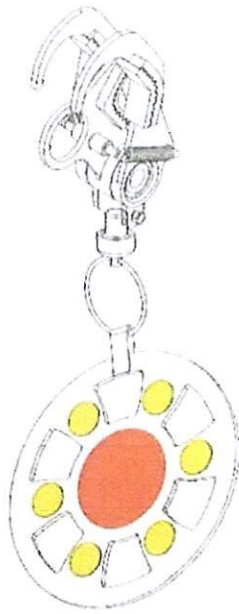

| Sr. No | PART Description (BOM) | Description | QTY |
|--------|------------------------|--|-----|
| A | UNIVERSAL CLAMP | High Grade Engineering Polymer | 1 |
| B | CONNECTING ROD | STAINLESS STEEL - corrosion free | 1 |
| C | HIGH TENSILE SPRING | STAINLESS STEEL - corrosion free | 2 |
| D | HOLDING SHAFT | STAINLESS STEEL - corrosion free | 2 |
| E | ROTATING MECHANISM | Self lubricating ball bearing with High Grade Engineering Polymer Case Cover | 1 |
| F | FLAPPER Ø195MM | High grade engineering Polymer | 1 |

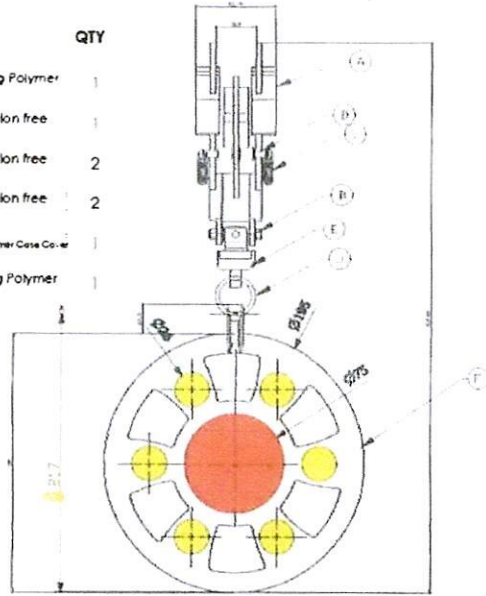

Bird Deflector installed on top conductor

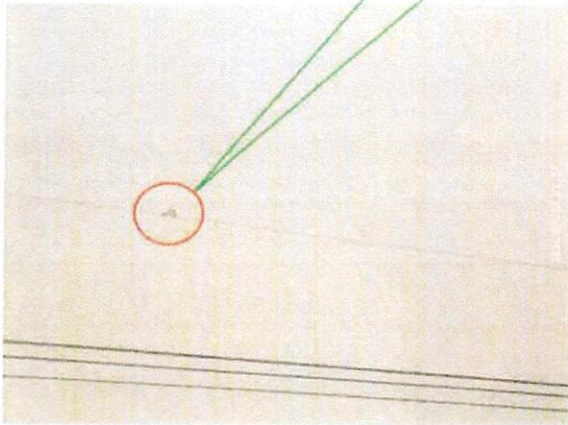

Bird Deflector installed on top conductor

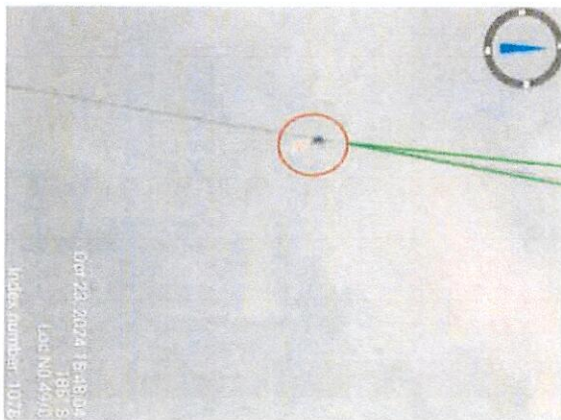



FCA Projects, Diverted Land, CA Land Management

Home FCA-1980 Projects Diverted Lands CA Lands Reports

Detailed Summary of Selected FCA Project

Project Basic details

| S.No. | Project Name | Project Year | Project Type | Purpose of Diversion | Total Land Diverted | User Agency |
|-------|--|--------------|-------------------|--|---------------------|-------------|
| 1 | Construction of 400 kV DC Bongaigaon Nangalbibra Transmission Line | 2023 | Transmission Line | Diversion of 61.600 ha of Forest Area for Construction of 400 kV DC Bongaigaon Nangalbibra Transmission Line under Haltugaon, Aie valley and Goalpara Forest Divisions | 61.600 | |

Details of Diverted forest land

| S.No. | Area Diverted (In Hac) | Division | Range | Forest Type | Location |
|-------|------------------------|------------|---------------|---|-----------------|
| 1 | 0.666 | Haltugaon | Nayekgaon | Reserved Forest (RF) | Satbhendi RF |
| 2 | 10.355 | Goalpara | Goalpara | Reserved Forest (RF) | Pancharatna RF |
| 3 | 16.325 | Goalpara | Goalpara | Proposed Protected Forest (Proposed PF) | Bogulamari PRF |
| 4 | 1.976 | Goalpara | Goalpara | Reserved Forest (RF) | Sagunbasi RF |
| 5 | 4.085 | Goalpara | Goalpara | Proposed Protected Forest (Proposed PF) | Rakshasini PRF |
| 6 | 9.006 | Goalpara | Consolidation | Reserved Forest (RF) | Zangrazangsa RF |
| 7 | 19.187 | Aie Valley | Abhayapuri | Reserved Forest (RF) | Bhairab RF |

Details of Lands received from user agency for Compensatory Afforestation

| S.No. | Land Type | Area(in Ha) | District | Range | Notification order No. |
|-------|--------------------------|-------------|----------|----------------------------|------------------------|
| 1 | Degraded Notified Forest | 1.350 | | Nayekgaon [Haltugaon] | |
| 2 | Degraded Notified Forest | 10.000 | | Lakhipur [Goalpara] | |
| 3 | Degraded Notified Forest | 39.000 | | Consolidation [Goalpara] | |
| 4 | Degraded Notified Forest | 25.000 | | Consolidation [Goalpara] | |
| 5 | Degraded Notified Forest | 10.000 | | Rongjuli [Goalpara] | |
| 6 | Degraded Notified Forest | 40.000 | | Abhayapuri [Aie Valley] | |

Details of the amount demanded from UA against the FCA project

| S.No. | FCA Proj. File No | Project Name | State | Proj. Year | Order No. | Date | NPV | CA | ACA | PCA | PAF | CAT | SZ | Others | Total Demanded | |
|-------|-------------------------|--|-------|------------|----------------------|------------|----------|----------|-----|-----|-----|-----|----|----------|----------------|-----------|
| 1 | FP/AS/TRANS/152968/2022 | Construction of 400 kV DC Bongaigaon Nangalbibra Transmission Line | AS | 2023 | A/HFD/LD/NDTL/390-91 | 09/06/2023 | 75053651 | 64211144 | 0 | 0 | 0 | 0 | 0 | 63594858 | 202859653 | |
| Total | | | | | | | 75053651 | 64211144 | 0 | 0 | 0 | 0 | 0 | 0 | 63594858 | 202859653 |

Details of the amount received from UA against the FCA project.

| S.No. | FCA Project File No | Proj. Name | State | Proj. Year | Ref. No. | Ref. Date | Receipt Date | NPV | CA | ACA | PCA | PAF | CAT | SZ | Others | Total Received |
|-------|-------------------------|--|-------|------------|----------------------|------------|--------------|----------|----------|-----|-----|-----|-----|----|----------|----------------|
| 1 | FP/AS/TRANS/152968/2022 | Construction of 400 kV DC Bongaigaon Nangalbibra Transmission Line | AS | 2023 | A/HFD/LD/NDTL/390-91 | 09/06/2023 | 11/07/2023 | 75053651 | 64211144 | 0 | 0 | 0 | 0 | 0 | 63594858 | 202859653 |
| Total | | | | | | | | 75053651 | 64211144 | 0 | 0 | 0 | 0 | 0 | 63594858 | 202859653 |

Lock and Print Details

Go Back

NANGALBIBRA-BONGAIGAON TRANSMISSION LIMITEDDLF Cyber Park Tower-B, 9th Floor, Udyog Vihar Phase-III,
Sector-20, Gurugram-122008, Haryana India +91 0124 4562 000

Date: 23-03-2026

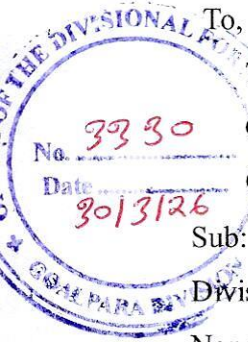
To,
The Divisional Forest Officer,
Goalpara Forest Division,
Goalpara, AssamSub: Proposal for diversion of 61.6 ha (19.187 ha in Aie Valley Division, 41.747 in Goalpara Division, 0.666 ha in Haltugaon Division) forest area for construction of 400 kV D/C Bongaigaon-Nangalbibra Transmission line— **submission of pointwise compliance report of the in-principle approval and request for processing the proposal for issuance of final approval.**

Ref:

1. In-Principle approval accorded by the MoEFCC, IRO Shillong vide F. No. 3 -AS B 157/2023 -GHY/3649-50, dated 28.02.2023.
2. Demand note raised by the DFO vide letter No. B/GLP/DFO(T)/FCA/Diversion Proposal/Sterlite Power/1402, dated 13.03.2023.
3. Demand letter of the PCCF Wildlife and Chief Wildlife Warden, Assam vide No. WL/FG/Proposal/Bongaigaon-Nangalbibra Trans line, dated 23.05.2025
4. Demand letter raised from the DFO, Aie Valley Division, Bongaigaon vide letter no. B/AVD/Sterlite/400kv/2025/3833, dated 08.07.2025.

Dear Sir,

With reference to the above, please find enclosed the revised pointwise compliance report of the In-Principle approval accorded by the MoEFCC, IRO Shillong vide F. No. 3-AS B 157/2023GHY/3649-50, dated 28th February 2023 along with necessary enclosures.

All the compensatory levies have been deposited to the Ad-hoc CAMPA Account and the given account of the DFO, Aie Valley which are tabulated below for ready reference.

| Txn Posted Date | UTR No./ Description | Payment head | Transaction Amount (INR) |
|-----------------|---|---|--------------------------|
| 10/04/2023 | RTGS: ICICR52023041000244886/ UBIN0996335/ASSAMCAMP | NPV, CA, Overhead Cost and Medicinal Plantation in CAMPA through e-challan | 12,62,76,457 |
| 27/04/2023 | UTR No. ICICR52023052300638561/SBIN00000 82/DIVISIONAL FOREST OFFICER | Erection of boundary pillars | 6,61,196 |
| 27/04/2023 | UTR No. ICICR52023052300638561/SBIN0000 082/DIVISIONAL FOREST OFFICER | Departmental operation | 14,57,700 |

NANGALBIBRA-BONGAIGAON TRANSMISSION LIMITED

DLF Cyber Park Tower-B, 9th Floor, Udyog Vihar Phase-III,
Sector-20, Gurugram-122008, Haryana India +91 0124 4562 000



| | | | |
|------------|---|--|-------------|
| 27/04/2023 | UTR No. ICICR52023052300638561/SBIN0000 082/DIVISIONAL FOREST OFFICER | Maintenance timber depot and security Camp | 23,90,800 |
| 27/04/2023 | UTR No. ICICR52023052300638561/SBIN0000 082/DIVISIONAL FOREST OFFICER | Hiring good quality Mahindra vehicles | 24,34,550 |
| 04/04/2024 | UTR No. ICICR52024040400571353/SBIN0000 082/DIVISIONAL FOREST OFFICER | Departmental operation | 42,56,220 |
| 13/03/2026 | UTR No. HDFCR52026031381539908 CAMPA | Wildlife Conservation and Management Plan | 1,10,13,814 |
| 20/03/2026 | NEFT Ref No. NBTL200326R1 DFO, Aie Valley | Cost of Plantation of Fruits tree for Golden Langur | 73,03,855 |
| 20/03/2026 | NEFT Ref No. NBTL200326R1 DFO, Aie Valley | 10 Nos JFMC for 5 years | 4,65,25,000 |

In view of the above, you are requested to process the compliance report for issuance of the final approval from the competent authority.

Thanking You,

Nangalbibra-Bongaigaon Transmission Ltd



(Authorized Signatory)
Narottam Chakraborty
Head- Forest & Wildlife

Copy to:

1. The Chief Conservator of Forests and the Nodal Officer (FC Act), Assam, Guwahati for kind information please.

Encl: Pointwise compliance report along with the enclosures.

NANGALBIBRA-BONGAIGAON TRANSMISSION LIMITED

Project Office: Sambriddhi Complex 2nd floor, Pancharatna Road,
Goalpara, Assam.

**COMPLIANCE REPORT**

Pointwise compliance of the in-principle approval No. 3-AS B157/2023-GHY/3649-50, dated 28.02.2023 of the MoEF&CC, IRO Guwahati, for the diversion of 61.6 ha of forest land for construction of 400 kV D/C Bongaigaon to Nangalbibra Transmission line under Haltugaon, Aie Valley, and Goalpara Forest divisions.

A. Conditions need to be complied with prior handing over of forest- land by the State Forest Department:

| Sl. No. | Conditions as per In-Principle approval vide F.No. 3-AS B 157/2023-GHY/3649-50 | Compliance |
|---------|---|---|
| 1 | The User Agency shall transfer, the Net Present Value (NPV) of the forest land being diverted under this proposal as per the orders of the Hon'ble Supreme Court of India dated 28/03/2008, 24/04/2008 and 09/05/2008 in Writ petition (Civil) No. 202/1995 and as per guidelines issued by the Ministry vide letters No. 5-3/2007- FC, dated 05.02.2009 and File No. 5-3/2011FC(Vol-I), dated 21.03.2022. The requisite funds shall be transferred through online portal into CAMPAs account of the State concerned. | <p>Aie Valley Forest Division- The NPV amounting Rs. 8,61,039/- has been deposited in CAMPAs account vide UTR No: ICICR52023041000244178 /UBIN099 6335/ASSAM CAMPAs, dated 10.04.2023 reference to letter No. A/AVD /400KV/718-20, dated 13.03.2023 of the Divisional Forest Officer, Aie Valley forest division.</p> <p>Haltugaon Forest Division- The NPV amounting Rs. 2,75,65,387.30/- has been deposited in CAMPAs account vide UTR No: ICICR52023041000244178/UBIN0996335/ASSAM CAMPAs, dated 10.04.2023 reference to letter No. B/HFD/LD/NBTL/3653, dated 04.03.2023 of the Divisional Forest Officer, Haltugaon Forest Division</p> <p>Goalpara Forest Division- The NPV amounting Rs. 4,66,27,225/- has been deposited in CAMPAs account vide UTR No: ICICR52023041000244178/UBIN0996335/ASSAM CAMPAs, dated 10.04.2023 reference to letter No. B/GLP/ DFO(T) /FCA /Diversion proposal/Sterlite Power/1402, dated 13.03.2023 of the Divisional Forest Officer, Goalpara Forest Division.</p> <p>Online payment confirmation is enclosed as Annexure-I.</p> |
| 2 | The User agency shall transfer the cost of raising and maintaining the Compensatory Afforestation at the current wage rate in consultation with State Forest Department in the account of CAMPAs of the concern state through online portal. The Scheme may include appropriate provision for anticipated cost increase for work scheduled for subsequent years. | <p>Aie Valley Forest Division- The cost of Compensatory Afforestation amounting Rs. 2,72,71,634.34/- has been deposited in CAMPAs account vide UTR No: ICICR52023041000244178/UBIN0996335/ASSAM CAMPAs, dated 10.04.2023 in reference to letter No. A/AVD/ 400KV/718-20, dated 13.03.2023 of the Divisional Forest Officer, Aie Valley forest division.</p> <p>Haltugaon Forest Division- The cost of Compensatory Afforestation amounting Rs. 33,94,500/- has been deposited in CAMPAs account vide UTR No: ICICR52023041000244178/UBIN099633 5/ASSAM CAMPAs, dated 10.04.2023 in reference to letter No. B/HFD/LD/NBTL/3653, dated 04.03.2023 of the Divisional Forest Officer, Haltugaon Forest Division.</p> <p>Goalpara Forest Division- The cost of Compensatory Afforestation amounting Rs. 6,55,60,057/- has been deposited in CAMPAs account vide UTR No. ICICR52023041000244178/UBIN099633 5/ASSAMCAMPAs, dated 10.04.2023 in reference to letter No.B/GLP/DFO(T) /FCA/Diversion Proposal/Sterlite Power/1402, dated 13.03.2023 of the Divisional Forest Officer, Goalpara Forest Division.</p> <p>Online payment confirmation is enclosed as Annexure-I.</p> |

NANGALBIBRA-BONGAIGAON TRANSMISSION LIMITED

Project Office: Sambriddhi Complex 2nd floor, Pancharatna Road,
Goalpara, Assam.



| | | |
|---|--|--|
| 3 | All the funds received from the user agency (CA and dwarf plantation cost, NPV etc.) under the project shall be transferred/deposited to compensatory Afforestation Fund of Assam State managed by the Ad-hoc CAMPA only through e- portal (https://parivesh.nic.in/). Amount deposited through other mode will not be accepted as compliance of Stage-I clearance. | The total amount of Rs. 191845839/- has been deposited in CAMPA account vide UTR No: ICICR52023041000244178/UBIN0996335/ASS AMCAMP, dated 10.04.2023 in reference to the demand note of concerned Divisional Forest Officers, Assam. Online payment confirmation is enclosed as Annexure-I . |
| 4 | The KML files of the area to be diverted, the CA areas, the proposed SMC work, the proposed Catchment Area Treatment area and the WLMP area shall be uploaded on the e-Green watch portal with all requisite details before issuing working permission towards linear projects or submitting compliance report for seeking Stage-II approval, as the case may be. | Noted and shall be ensured. |
| 5 | The boundary of the diverted forest land shall be suitably demarcated on ground at the project cost, as per the direction of the concerned Divisional Forest Officer | <p>Aie Valley Forest Division- The boundary of the diverted forest land has been demarcated on ground at project cost by forest department. The amount of Rs. 7,69,850/- has been deposited in this regard at ICICI bank account no. 070805000767 as directed by the DFO, Aie Valley vide letter no. B/AVD/400KV/2156, dated 06/06/2023.</p> <p>Haltugaon Forest Division- The cost of Rs. 10,10,000/- for departmental operation of trees & boundary pillars, has been deposited, as directed by DFO, Haltugaon vide letter No.B/HFD/LD/NBTL/430, dated 07.05.2023.</p> <p>Goalpara Forest Division- The cost of Rs. 69,49,246/- for Departmental operation of trees & boundary pillars, has been deposited, as directed by DFO, Goalpara vide Letter No. B/GLP/DFO(T)/Diversion Proposal/Sterlite Power/2021, dated 17.04.2023.</p> <p>Photographs are enclosed as Appendix -I</p> |
| 6 | The user agency shall deposit 2% of the total project cost for Human Elephant Conflict mitigation and wildlife conservation purposes and the amount shall be deposited into account of CAMPA. | Reference to the demand letter of the PCCF Wildlife and Chief Wildlife Warden, Assam vide No. WL/FG/Proposal/Bongaigaon-Nangalbibra Trans line, dated 23.05.2025 the cost for Human Elephant Conflict mitigation and wildlife conservation purposes an amount of Rs.1,10,13,814/- (One Crore Ten Lakhs Thirteen Thousand Eight Hundred and Fourteen only) has been deposited in Ad-hoc CAMPA Account vide UTR No-HDFCR52026031381539908, dated 13.03.2026. The copy of above demand letter and payment details are enclosed as Annexure-I A . |
| 7 | The State Govt shall ensure that under no circumstances, implementation of such mitigation measures envisaged in Human Elephant/ Wildlife Conflict mitigation and wildlife conservation plan should be delayed beyond a period of 2 years to ensure commencement of rejuvenation of ecosystem services lost from the forest area allowed for non- forestry use of forest land at the earliest possible time | Noted. |
| 8 | The State Govt shall submit Human Elephant/wildlife Conflict mitigation and wildlife conservation plan approved by | As per demand letter received from the PCCF Wildlife and Chief Wildlife Warden, Assam vide No. WL/FG/Proposal/Bongaigaon-Nangalbibra Trans line, dated 23.05.2025 and demand letter of the |

NANGALBIBRA-BONGAIGAON TRANSMISSION LIMITED

Project Office: Sambriddhi Complex 2nd floor, Pancharatna Road, Goalpara, Assam.



| | | |
|-----------|---|---|
| | <p>Chief Wildlife Warden, Govt. of Assam along with detail cost of its implementation.</p> | <p>DFO, Aie Valley Division, dated 08.07.2025 amount of Rs. 1,10,13,814/- has been deposited in Ad-hoc CAMPA Account vide UTR No- HDFCR52026031381539908, dated 13.03.2026 and Rs. 5,38,28,855/- has been deposited to the bank account of the DFO, Aie Valley Division, through NEFT vide Ref No. NBTL200326R1 dated 20.03.2026.</p> |
| <p>9</p> | <p>The State Govt. shall ensure to comply strictly to the following recommendation of the CWLW, Govt. of Assam: -</p> <p>a. Ground clearance shall be minimum of 15 m as proposed by the UA.</p> <p>b. Three-layer protection measures will be adopted to ensure complete safety and minimum interference with fauna. The measures include barbed fencing of tower area, Special tower design having soft material anti-climbing guards & anti-climbing canopy which will restrict any arboreal animals from climbing on towers.</p> <p>c. User Agency shall prepare and submit WL Management Plans suggested by Forest & WL Department.</p> <p>d. The User agency shall do plantation of fruit trees especially for Golden Langur in and around the Golden Langur habitat area through forest department.</p> <p>e. The user agency shall provide fund and support 10 Nos. of JFMCs for five years in and around Bhairab RF and other nearby forest which are habitat for Golden Langur for taking up Entry point Activity, livelihood activities, ecotourism facilities and capacity building for local youth.</p> <p>f. Felling of trees will be restored only at proposed tower locations and other areas shall be avoided.</p> | <p>All the mentioned conditions will be complied with.</p> <p>a. Ground clearance has been maintained minimum of 15 m along the route in Bhairab RF.</p> <p>b. Three-layer protection measures have been adopted at all the towers in Bhairab RF. Photographs enclosed as Appendix II.</p> <p>c. Reference to the demand letter of the PCCF Wildlife and Chief Wildlife Warden, Assam vide No. WL/FG/Proposal/Bongaigaon-Nangalbibra Trans line, dated 23.05.2025 the cost for Human Elephant Conflict mitigation and wildlife conservation purposes an amount of Rs. 1,10,13,814/- (One Crore Ten Lakhs Thirteen Thousand Eight Hundred and Fourteen only) has been deposited in Ad-hoc CAMPA Account vide UTR No- HDFCR52026031381539908, dated 13.03.2026. The copy of above demand letter and payment details are enclosed as Annexure-I A.</p> <p>d. The cost of plantation of fruit trees especially for Golden Langur in and around the Golden Langur habitat area amounting to Rs. 73,03,855/- (Rs. Seventy Three Lakhs Three Thousand and Eight Hundred and Fifty Five only) has been deposited to the bank account of the DFO, Aie Valley Division, Bongaigaon through NEFT vide Ref No. NBTL200326R1, dated 20.03.2026 against demand letter raised from the DFO, Aie Valley Division, Bongaigaon, dated 08.07.2025. The copy of above demand letter and payment details are enclosed as Annexure -I A.</p> <p>e. The cost of supporting 10 Nos of JFMCs for five years in and around Bhairab RF and other nearby forest amounting to Rs. 4,65,25,000/- (Rs. Four Crore Sixty-Five Lakhs and Twenty Five Thousand only) has been deposited to the bank account of the DFO, Aie Valley Division, Bongaigaon through NEFT vide Ref No. NBTL200326R1, dated 20.03.2026 against demand letter raised from the DFO, Aie Valley Division, Bongaigaon, dated 08.07.2025. The copy of above demand letter and payment details are enclosed as Annexure -I A.</p> <p>f. Felling of trees have been restricted at the tower locations and bare minimum in the corridor to maintain safe electrical clearance as per Indian standard.</p> |
| <p>10</p> | <p>The user agency shall explore the possibility of successful translocation of maximum number of trees identified to be felled shall be explored and any tree felling shall be done only when it is unavoidable and that too under strict supervision of the State Forest department.</p> | <p>Translocation of trees have been explored, and unavoidable trees were only felled by the forest department.</p> |

Beauty

NANGALBIBRA-BONGAIGAON TRANSMISSION LIMITED

Project Office: Sambriddhi Complex 2nd floor, Pancharatna Road,
Goalpara, Assam.



| | | |
|----|---|---|
| 11 | The charges for felling, logging and transportation of project affected trees should be collected from the User Agency at the rates approved by the State Govt and deposited with the DFO concerned for utilization immediately following the diversion of forest land. | <p>Aie Valley Forest Division- The cost of Departmental operation of trees has been deposited in the ICICI bank account no. 070805000767 as directed by the DFO, Aie Valley vide letter No. B/AVD/400KV/2156, dated 06/06/2023.</p> <p>Haltugaon Forest Division- The cost of Rs. 10,10,000/- for departmental operation of trees & boundary pillars, has been deposited, as directed by the DFO, Haltugaon vide letter No. B/HFD/LD/NBTL/430, dated 07.05.2023.</p> <p>Goalpara Forest Division- The cost of Rs. 69,49,246/- for Departmental operation of trees & boundary pillars, has been deposited, as directed by the DFO, Goalpara vide letter No. B/GLP/DFO(T)/Diversion Proposal/Sterlite Power/2021, dated 17.04.2023.</p> |
| 12 | The expenditure like boundary walls, stone pillars, demarcation charges, cost of damage of trees the funds on these accounts should be deposited with the DFO concerned. | <p>Aie Valley Forest Division- The cost of boundary pillars and Departmental operation of trees has been deposited in the ICICI bank account no. 070805000767 as directed by the DFO, Aie Valley vide Letter No. B/AVD/400KV/2156, dated 06.06.23 & B/AVD/400KV/BNG to Nagalbibra/2024/3364, dated 08.08.24.</p> <p>Haltugaon Forest Division- The cost of Rs. 10,10,000/- for departmental operation of trees & boundary pillars, has been deposited, as directed by the DFO, Haltugaon vide letter No. B/HFD/LD/NBTL/430, dated 07.05.2023.</p> <p>Goalpara Forest Division- The cost of Rs. 69,49,246/- for Departmental operation of trees & boundary pillars, has been deposited, as directed by the DFO, Goalpara vide letter No. B/GLP/DFO(T)/Diversion Proposal/Sterlite Power/2021, dated 17.04.2023.</p> |
| 13 | The User Agency shall restrict the felling of trees to minimum number in the diverted forest land and the trees will be felled under the strict supervision of the State Forest Department, and the cost of felling of trees has been deposited to the state Forest Department. | Unavoidable trees were only felled by Forest Department & cost of felling has been deposited as per demand of all the concerned DFO. |
| 14 | The complete compliance of the FRA, 2006 shall be ensured by way of prescribed certificate from the concerned District Collector. | The complete compliance of the FRA, 2006 have been completed in all three districts. FRA certificates enclosed as Annexure-III . |
| 15 | Violation of any of these conditions will amount to violation of Forest (conservation) Act, 1980 and action would be taken as prescribed in para 1.21 of chapter 1 of the Handbook of comprehensive guidelines of Forest (conservation) Act, 1980 as issued by this Ministry's letter No. 5-2/2017-Fc dated 28.03.2019. | Agreed. Undertaking in this regard is enclosed as Annexure-II . |
| 16 | The User Agency in consultation with the State Forest Department prepare a detailed scheme for creation and maintenance of plantation of dwarf species (preferably medicinal plants) in right of way under the transmission line for execution of the said scheme to the State Forest Department. | Aie Valley Forest Division- The detailed scheme for creation and maintenance of plantation of dwarf species in right of way under the transmission line has been prepared. The cost of Dwarf Plantation Rs. 48,22,821/- has been deposited in CAMPA account vide UTR No: ICICR52023041000244178/UBIN099633/ASSAM CAMPA, dated 10.04.2023 in reference to letter No. A/AVD/400KV/718-20, dated 13.03.2023 of the Divisional Forest Officer, Aie Valley forest division. |

Amity

NANGALBIBRA-BONGAIGAON TRANSMISSION LIMITED

Project Office: Sambriidhi Complex 2nd floor, Pancharatna Road,
Goalpara, Assam.



| | | |
|----|--|---|
| | | <p>Haltugaon Forest Division- The detailed scheme for creation and maintenance of plantation of dwarf species in right of way under the transmission line has been prepared. The cost for Dwarf Plantation Rs. 16,54,000/- has been deposited in CAMPA account vide UTR No: ICICR52023041000244178/UBIN0996335/ASSAM CAMPA, dated 10.04.2023 in reference to letter No. B/HFD/LD/NBTL/3653, dated 04.03.2023 of the Divisional Forest Officer, Haltugaon Forest Division.</p> <p>Goalpara Forest Division- The detailed scheme for creation and maintenance of plantation of dwarf species in right of way under the transmission line has been prepared. The cost for Dwarf Plantation Rs. 1,40,89,175/- has been deposited in CAMPA account vide UTR No: ICICR52023041000244178/UBIN099633/ASSAM CAMPA, dated 10.04.2023 in reference to letter No.B/GLP/DFO(T)/FCA/Diversion Proposal/ Sterlite Power/1402, dated 13.03.2023 of the Divisional Forest Officer, Goalpara Forest Division.</p> <p>Online payment confirmation enclosed as Annexure-I.</p> |
| 17 | The compliance report shall be uploaded on -c-portal (https://parivesh.nic.in) | Noted and shall be complied. |

B. Conditions need to be strictly complied on field after handing over of forest- land to the user agency by the State Forest Department but the compliance in form of undertaking shall be submitted prior to Stage-II approval:

| Sl. No. | Conditions as per In- Principle approval vide F.No. 3-AS B 157/2023-GHY/3649-50 | Compliance |
|---------|---|---|
| 1 | Legal status of forest land proposed for diversion shall remain unchanged. | Agreed. Undertaking in this regard is enclosed as Annexure-II . |
| 2 | The compensatory Afforestation shall be taken up on doubled the degraded forest land of 125.35 ha which has been identified in three different patches i.e. 1.35 ha in Nayekgaon Range, Haltugaon Forest Division in Kokrajhar district; 84 ha in Lakhipur Range in Nalbari RF (10 ha), Central Range, Krishnai, Zengrazanga (39 ha), Central Krishnai Zengrazanga (25 ha), Rongjuli Dolngdo Reserve Forest (10 ha) in Goalpara District; and 40 ha in Abhayapuri Range, Aie vally Forest Division in Bongaigaon District of Assam within three years from the date of Stage-II clearance and maintained thereafter by the State Forest Department at the cost of the User Agency. As far as possible, a mixture of local indigenous species shall be planted, and monoculture of any species may be avoided. The CA will be maintained for 10 years. | Cost for raising Compensatory Afforestation for all the locations in three Forest Divisions has been deposited in CAMPA account vide UTR No: ICICR52023041000244178/UBIN0996335/ASSAM CAMPA, dated 10.04.2023. Online payment confirmation enclosed as Annexure-I |
| 3 | At the time of payment of the Net Present Value (NPV) at the time of prevailing rate, the User Agency shall furnish an undertaking to pay the additional amount of NPV, if so determined, as per final decision of the Hon'ble Supreme Court of India | Agreed. Undertaking in this regard is enclosed as Annexure-II . |
| 4 | The User Agency shall obtain the Environment Clearance as per the provisions of Environment (Protection) Act, 1986, if required (NA). | Not applicable for transmission line projects. |
| 5 | No labour camp shall be established on the forest land and fuels preferably the alternated fuel to labourers and the staff working at the site shall be provided so as to avoid any damage and pressure on the nearby forest areas. | Agreed. Undertaking in this regard is enclosed as Annexure-II . |
| 6 | The forest land proposed to be diverted shall under no circumstances be transferred to any other agencies. | Agreed. Undertaking in this regard is enclosed as Annexure-II . |

Amity

NANGALBIBRA-BONGAIGAON TRANSMISSION LIMITED

Project Office: Sambriddhi Complex 2nd floor, Pancharatna Road,
Goalpara, Assam.



| | | |
|----|--|--|
| | department, or person without prior approval of the Govt. of India. | |
| 7 | No damage to the flora and fauna of the adjoining areas shall be caused. | Shall be complied. Undertaking in this regard is enclosed as Annexure-II . |
| 8 | The layout of the proposal shall not be changed without prior approval of the central Govt. | Agreed. Undertaking in this regard is enclosed as Annexure-II . |
| 9 | The concerned Divisional Forest Officer will monitor and take necessary mitigative measures to ensure that there is no adverse impact on the forests in the surrounding Area. | Noted. |
| 10 | The User Agency at its cost shall provide bird deflectors which are to be fixed on the upper conductor of transmission line at suitable interval to avoid bird hits. | The bird deflectors have been installed on the upper conductor of transmission line at suitable interval. Photographs enclosed as Appendix III . |
| 11 | The User Agency shall comply all the provision of all Acts, Rules, Regulations, Guidelines, Hon'ble Court Order(s) and NGT Order(s) pertaining to this project, if any, for the time being in force as applicable to the project | Agreed. Undertaking in this regard is enclosed as Annexure-II . |
| 12 | The User Agency shall comply with the guidelines for laying transmission through forest areas issued by Ministry vide letter No. 7-25/2012-FC, dated 5/05/2014 & 19/11/2014. | Agreed. Undertaking in this regard is enclosed as Annexure-II . |
| 13 | No additional or new path will be constructed inside the forest area for transportation of construction materials for execution of the project work. | Agreed. Undertaking in this regard is enclosed as Annexure-II . |
| 14 | The period of diversion under this approval shall be co-terminus with the period of lease to be granted in favour of the user agency or the project life, whichever is less. | Agreed. |
| 15 | The forest land shall not be used for any purpose other than that specified in the project proposal. | Agreed. Undertaking in this regard is enclosed as Annexure-II . |
| 16 | As per Ministry's letter no 11-30/96-FC (Pt) dt. 14.9.2001 if the compliance of stipulated conditions is awaited from the State Govt for more than 5 (five) years, the in-principle approval would be summarily revoked considering that the user agency is no longer interested in the project. | Agreed. |
| 17 | Any other conditions that the Integrated Regional Office, Guwahati, MoEFCC may be stipulated from time to time in the interest of conservation protection and development of Forest & Wildlife | Agreed. |

Date: 23/03/2026

Signature:

Name: Narottam Chakraborty

Designation: Head- Forest & Wildlife

Nagalbibra-Bongaigaon Transmission Ltd.

Address of Agency:

Resonia Limited,

5th Floor, RMZ Infinity, Plot No 15

Phase IV, Sec-18, Gurugram, Haryana, 122015.

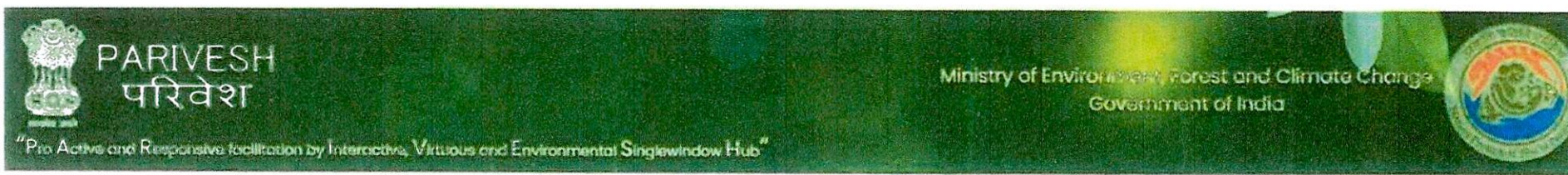

My Account ▾ My Proposals Environment Clearance ▾ Only CRZ Clearance ▾ My Proposals Forest Clearance ▾ My Proposals Wildlife Clearance ▾ Help ▾

3:07:26 PM

Online payment history made by User Agency under CAMPA

Help

| Sno. | Proposal Detail | Application_No | Application No (New) | Date of IN-PRINCIPLE | Amount to be Paid/Amount Paid (in Rs.) | Payment Status | Payment Detail | Demand Letter |
|------|--|--------------------|----------------------|----------------------|--|----------------|--|------------------------------------|
| 1 | PRAS TRANS/152968/2023 Construction of 400 kv DC Bongaigaon Nangalbibra Transmission Line | TRANS1529682022966 | 54152968966 | 28 Feb 2023 | CA: 96226192/- Addl CA : 0/- PCA: 0/- CAT : 0/- Safety Zone: 0/- Addl PA : 0/- NPV: 75053651/- Dwarf Species (Medicinal) Plantation : 20565996/- Other Charges1 : 0/- Other Charges2 : 0/- Other Charges3 : 0/- Total : 191845839/- | Paid | Fund Demand Verified by Nodal Officer On : 15 Mar 2023 Bank Name : Union Bank Of India Mode of Payment : NEFT/RTGS (Challan) Challan Generated On : 25 Mar 2023 Transaction Date : 11 Apr 2023 | Demand Letter Generated Challan |



NANGALBIBRA-BONGAIGAON TRANSMISSION LIMITED

DLF Cyber Park Tower-B, 9th Floor, Udyog Vihar Phase-III,
Sector-20, Gurugram-122008, Haryana India +91 0124 4562 000



ANNEXURE- I A

PAYMENT DETAILS

| Date | UTR No | Payment Description | Payment Head | Transaction Amount |
|------------|-----------------------------------|---|-------------------------------------|--------------------|
| 13/03/2026 | UTR No. HDFCR52026031381539908 | Wildlife Conservation and Management Plan | CAMPA Assam A/C No. 150617299 | 1,10,13,814 |
| 20/03/2026 | NEFT Ref No. NBTL200326R1 | Cost of Plantation of Fruits tree for Golden Langur | A/C No. 070805000767 | 73,03,855 |
| 20/03/2026 | NEFT Ref No. NBTL200326R1 | 10 Nos JFMC for 5 years | A/C No. 070805000767 | 4,65,25,000 |



(Authorized Signatory)

Narottam Chakraborty
Head- Forest & Wildlife
Nangalbibra Bongaigaon Transmission Ltd.



GOVERNMENT OF ASSAM
OFFICE OF THE PRINCIPAL CHIEF CONSERVATOR OF FORESTS, WILDLIFE AND
CHIEF WILDLIFE WARDEN, ASSAM

Email ID: pccf.wl.assam@gmail.com

No. WL/FG/Proposal/Bongaigaon-Nangalbibra Trans line

Date: 23.05.2025

To,

The Chief Manger,
Nangalbibra-Bongaigaon Transmission Ltd.,
2nd Floor, Samriddhi Complex, New Market,
Pancharatna Road, Goalpara, Assam-783101.

Sub: Deposition of 2% project cost for Human Elephant/Wildlife Conflict Mitigation & Wildlife Conservation purpose against proposal for "diversion of 61.6 Ha. of forest land for construction of 400 kV D/C Bongaigaon to Nangalbira Transmission Line in Sathbandi RF, Bhairab RF, Pancharatna RF, Sagunbari RF, Zangrazangsa RF, Bogulmari PRF & Rakshashini PRF under haltugaon Division (area-0.66 Ha), Aie Valley Division (area-19.187 Ha) & Goalpara Division (41.747 Ha) by Nangalbibra-Bongaigaon Transmission Ltd".

Ref: 1. This office letter No. WL/FG/proposal/Bongaigaon-Nangalbibra Trans line, dated 07.06.2023.
2. Your office letter No. NBTL/FOREST/2025-26/01, dated 30.04.2025.

Sir,

Pursuant to the MoEF & CC, Govt of India's F.No. 3 AS B 157/2023-GHY/3649-50, dated 20.02.2023 granting "In Principle Approval/Stage-I" for the above-mentioned proposal and with reference to the subject and letters cited above, it is requested to deposit 2% of the proportionate project cost to the account of CAMPA, as estimated below:

- (a) Total area of the project both in the state of Assam & Meghalaya = 563.772 Ha.
- (b) Total area of project in the state of Meghalaya (non-forest + forest) = 243.496 Ha.
- (c) Total area of the project in the state of Assam (non-forest + forest) = 320.276 Ha.
- (d) Area of forest land proposed for diversion in the state of Assam = 61.6 Ha.
- (e) Proportionate cost of the project in the state of Assam = $320.276/563.772 \times \text{Rs } 504,00,00,000 = \text{Rs } 286,31,98,314/-$
- (f) **2% proportionate project cost** = $61.6/320.276 \times \text{Rs. } 286,31,98,314 \times 2\%$
= Rs 1,10,13,814/-

In view of the above, it is requested to deposit an above-mentioned amount of **Rs 1,10,13,814/- (one crore ten lakhs thirteen thousand eight hundred fourteen only)** for preparation and implementation of Human Elephant/Wildlife Conflict Mitigation & Wildlife Conservation and Management Plan with special emphasis on Golden Langur, in the account of CAMPA.

This is for your kind information and necessary action.

Yours faithfully,



(Dr. Vinay Gupta, IFS)
Principal Chief Conservator of Forests,
Wildlife & Chief Wildlife Warden, Assam.

Copy for information and necessary action to.

1. CCF & Nodal Officer (FC Act), Assam, O/o the PCCF & HoFF, Assam. This has a reference to this office letter No. WL/FG/Proposal/Bongaigaon-Nangalbibra Trans line, dated 26.12.2024 and your letter No. FG.27/FCA/Proposal/Nangalbibra-Bongaigaon Transmission Ltd., dated 18.02.2025.
2. DFO, Goalpara Division, Goalpara, Aie Valley Division, Bongaigaon & Haltugaon Division, Kokrajhar.



Principal Chief Conservator of Forests,
Wildlife & Chief Wildlife Warden, Assam.

Copy for information to Principal Chief Conservator of Forests & Head of Forest Force, Assam, Panjabari, Guwahati-37.



Principal Chief Conservator of Forests,
Wildlife & Chief Wildlife Warden, Assam.



GOVT. OF ASSAM
OFFICE OF THE DIVISIONAL FOREST OFFICER, AIE VALLEY DIVISION
BONGAIGAON.

E-mail- dfo.taievalley@gmail.com

Date: 08/07/25

No. B/AVD/Sterlite/400kv/2025/ 3883

To,

The Chief Manager
Sterlite Power Transmission Limited
2nd Floor, Samriddhi Complex
New Market, Pancharatna Road
Goalpara, Assam-783101

Sub: Demand note for submission of Human Elephant/Wildlife Conflict Mitigation and Wildlife Conservation Plan against the project "Construction of 400 KV DC Nangalbibra-Bongaigaon Transmission Line.

Ref: MoEF & CC Regional Office, Guwahati vide F.No.3 AS B 157/2023 GHY/3649-50,
dt. 28.02.2023 &

Your letter No. NBTL/FOREST/2025-26/02, dtd. 06.05.2025

Sir,

With reference to the subject cited above, you are requested to deposit the cost of plantation of fruit bearing species for Golden Langur & fund for 10(ten) nos. J.F.M.C. for implementing different activities within five years around the Bhairab Hill R.F. as per condition no. A.(9)(d) &(e) of the "In Principle Approval/Stage-I" clearance accorded by the Central Government vide Regional Office, Shillong, Ministry of Environment, Forest & Climate Change letter no. F.No. 3 AS B 157/2023 GHY/3649-50, dt. 28.02.2023 against the project "Construction of 400 KV DC Nangalbibra-Bongaigaon Transmission Line. The amount should be deposited in the following Bank Account and the details break up of amount shown below.

- | | | |
|------|---|--------------------------|
| (i) | Cost of raising plantation for fruit bearing species for Golden Langur | Rs. 73,03,855/- |
| (ii) | Cost of 10(ten) nos. J.F.M.C. for different schemes for five years around the Bhairab Hill R.F. | Rs. 4,65,25,000/- |
| | Total= | Rs. 5,38,28,855/- |

In words: (Rupees Five Crore Thirty Eight Lakh Twenty Eight Thousand Eight hundred Fifty Five) only

Bank Details:

Name of A/C holder : Divisional Forest Officer,
Aie Valley Division, Bongaigaon
Name of Bank : ICICI Bank, Bongaigaon Branch
Account No. : 70805000767
IFSC : ICIC0000708

This is for your kind information and necessary action.

Yours faithfully

H. Lalw
08/07/25
Divisional Forest Officer
Aie Valley Division
Bongaigaon

Date: 08/07/25

No. A/AVD/Sterlite/400kv/2025/ 3583-85

Copy to:

1. The Principal Chief Conservator of Forests, Wildlife & Chief Wildlife Warden, Assam, Panjabari, Guwahati-37 for favour of his kind information and necessary action.
2. The Chief Conservator of Forests & Nodal Officer (F.C. Act), Assam the Conservator of Forests, Lower Assam Social Forestry Circle, Bongaigaon for favour of his kind information.
3. The Conservator of Forests, Lower Assam Social Forestry Circle, Bongaigaon for favour of his kind information.

EP

H. Lalw
08/07/25
Divisional Forest Officer
Aie Valley Division
Bongaigaon

Norms for 20 ha Artificial Regeneration (AR) plantation with fruit bearing trees

Area (ha) = 20
 Spacing (m x m) = 2 X 2
 Wage Rate as per latest CAMPA norms = Rs. 353
 Total quantity of saplings to be planted = 50,000 nos.
 Total quantity of saplings to be raised/purchased = 82,500 nos.

| Sl no | Particulars of work | Units | Qty/Ha | Total Qty | Rate/Unit | Amount (Rs.) |
|----------|--|-------|--------|-----------|-----------|------------------|
| 7 | 3RD YEAR MAINTENANCE | | | | | |
| | 4 weeding, mulching and fire protection works @ 20 DLS/ha weeding | DLS | 80 | 1600 | 353 | 5,64,800 |
| | 15% vacancy filling by 2 years old seedling from site nursery/CAMPA nursery | DLS | 23 | 460 | 353 | 1,62,380 |
| | Maintenance and protection of field nursery and 1 no watch and ward for the plantation area for 365 days | DLS | 1 | 365 | 353 | 1,28,845 |
| | Maintenance of Camp Hut, implement, upkeep of plantation signboard, documentation, upkeep of records etc | LS | | | | 5000 |
| | Contingency | LS | | | | 15,000 |
| | Sub Total | | | | | 8,76,025 |
| 8 | 4TH YEAR MAINTENANCE | | | | | |
| | 4 weeding, mulching and fire protection works @ 15 DLS/ha weeding | DLS | 60 | 1200 | 353 | 5,64,800 |
| | 10% vacancy filling by 3 years old seedling from site nursery/CAMPA nursery | DLS | 20 | 400 | 353 | 1,41,200 |
| | Maintenance and protection of field nursery and 1 no watch and ward for the plantation area for 365 days | DLS | 1 | 365 | 353 | 1,28,845 |
| | Maintenance of Camp Hut, implement, upkeep of plantation signboard, documentation, upkeep of records etc | LS | | | | 5000 |
| | Contingency | LS | | | | 15,000 |
| | Sub Total | | | | | 8,54,845 |
| 9 | 5TH YEAR MAINTENANCE | | | | | |
| | 3 weeding, climber cutting & other silvicultural works and fire protection works @ 15 DLS/ha | DLS | 45 | 900 | 353 | 3,17,700 |
| | Maintenance and protection of field nursery and 1 no watch and ward for the plantation area for 365 days | DLS | 1 | 365 | 353 | 1,28,845 |
| | Maintenance of Camp Hut, implement, upkeep of plantation signboard, documentation, upkeep of records etc | LS | | | | 5000 |
| | Contingency | LS | | | | 15,000 |
| | Sub Total | | | | | 4,66,545 |
| | GRAND TOTAL | | | | | 73,03,855 |

Approved by

 Conservator of Forests
 Lower Assam Social Forestry Circle
 Bongaigaon

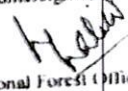
Countersigned by

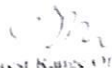
 Divisional Forest Officer
 Aic Valley Division
 Bongaigaon

Submitted by

 Forest Range Officer
 Abhayapuri Range
 Abhayapuri

| | | | |
|--|--|---|-------------------------|
| Band |  | | Date : 18/03/2026 |
| Certificate No. | G0R2026C574 |  | Stamp Duty Paid : ₹ 101 |
| GRN No. | 148841143 |  | Penalty : ₹ 0 |
| Deponent | | | |
| Name : | Nangal Bibra bongaigaon Transmission ltd | | |
| H.No/Floor : Na | Sector/Ward : 20 | Landmark : Tower b dif cyber park | |
| City/Village : Gurugram | District : Gurugram | State : Haryana | |
| Phone : 95*****48 | |  | |
| Purpose : FOR SUBMISSION OF COMPLIANCE to be submitted at Concerned office | | | |

The authenticity of this document can be verified by scanning this QR Code Through smart phone or on the website <https://egrashry.nic.in>

Annexure-II

Undertaking for compliance with the conditions of the in-principle approval No. 3-AS B157/2023-GHY/3649-50, dated 28.02.2023, for the diversion of 61.6 ha of forest land for construction of 400 kV D/C Bongaigaon to Nangalbibra Transmission line under Haltugaon, Aie Valley, and Goalpara Forest divisions:



- 1) As per condition No. 2 A (15) of the IPA we, Nangalbibra-Bongaigaon Transmission Ltd. do hereby undertake that **“no violation of any of the conditions shall be done and accept that violation of any of these conditions will amount to violation of forest conservation Act, 1980.”**
- 2) As per condition No. 2 B (1) of the IPA we, Nangalbibra-Bongaigaon Transmission Ltd. do hereby undertake that **“Legal status of forest land proposed for diversion shall remain unchanged.”**
- 3) As per condition No. 2 B (3) of the IPA we, Nangalbibra-Bongaigaon Transmission Ltd. do hereby undertake that **“additional amount of NPV, if so determined, as per final decision of the hon’ble supreme court of India shall be paid by us”.**
- 4) As per condition No. 2 B (5) of the IPA we, Nangalbibra-Bongaigaon Transmission Ltd. do hereby undertake that, **“no labour camp shall be established on the forest land and fuels preferably the alternated fuel to labourers and the staff working at the site shall be provided so as to avoid any damage and pressure on the nearby forest areas.**

- 5) As per condition No. 2 B (6) of the IPA we, Nangalbibra-Bongaigaon Transmission Ltd. do hereby undertake that **“the forest land proposed to be diverted shall under no circumstances be transferred to any other agencies, department or person without prior approval of Govt. of India”**.
- 6) As per condition No. 2 B (7) of the IPA we, Nangalbibra-Bongaigaon Transmission Ltd. do hereby undertake that **“no damage to the flora and fauna of the adjoining areas shall be caused.”**
- 7) As per condition No. 2 B (8) of the IPA we, Nangalbibra-Bongaigaon Transmission Ltd. do hereby undertake that **“layout of the proposal shall not be changed without the prior approval of the Central Government.”**
- 8) As per condition No. 2 B (11) of the IPA we, Nangalbibra-Bongaigaon Transmission Ltd. do hereby undertake that, **“compliance of all acts, rules, regulations, guidelines, the hon’ble court order(s) and NGT order(s) pertaining to this project, if any, for the time being in force as applicable to the project”**.
- 9) As per condition No. 2 B (12) of the IPA we, Nangalbibra-Bongaigaon Transmission Ltd. do hereby undertake **“to comply with the guidelines for laying transmission lines through forest areas issued by Ministry vide letter No- 7-25/2012/FC dated 05.05.2014 & 19/11/2014”**.
- 10) As per condition No. 2 B (13) of the IPA we, Nangalbibra-Bongaigaon Transmission Ltd. do hereby undertake that, **“no additional or new path will be constructed inside forest area for transportation of construction materials for execution of the project work”**.
- 11) As per condition No. 2 B (15) of the IPA we, Nangalbibra-Bongaigaon Transmission Ltd. do hereby undertake that, **“forest land shall not be used for any purpose other than that specified in the project proposal”**.

Date: 23/03/2026

Place: Goalpara

Signature:



Name: Narottam Chakraborty
Designation: Head- Forest & Wildlife
Nangalbibra Bongaigaon Transmission Ltd.

Address of Agency:

Resonia Limited,
5th Floor, RMZ Infinity, Plot No 15
Phase IV, Sec-18, Gurugram, Haryana, 122015

FORM-I

(for linear projects)
Government of Assam
Office of the Deputy Commissioner,
Goalpara

No. Rev/1487/2023-REV-GLP/71

Dated : 03rd June, 2023TO WHOM SO EVER IT MAY CONCERN

In compliance of the Ministry of Environment and Forests (MoEF), Government of India's letter No.11-9/98-FC(pt.) dated 3rd August, 2009, wherein the MoEF issued guidelines on submission of evidences for having initiated and completed the process of settlement of rights under the Scheduled Tribes and Other Traditional Forest Dwellers (Recognition of Forest Right) Act, 2006 ('FRA', for short) on the forest land proposed to be diverted for non-forest purposes read with MoEF's letter dated 5th February, 2013, wherein MoEF issued certain relaxation in respect of linear projects, it is certified that 41.747 hectares of forest land proposed to be diverted in favour of Sterlite Power for Construction of 400 KV D/C Bongaigaon-Nangalbibra Transmission Line in Goalpara district falls within jurisdiction of Pancharatna Hill RF, Bagulamari PRF, Sagunbahi RF, Rakhyasini PRF and Zangrajangsa RF under Balijana Tehsil.

It is further certified that:

- (a) The complete process for identification and settlement of rights under the FRA has been carried out for the entire.....hectares of forest area proposed for diversion. A copy of records of all consultations and meetings of the Forest Rights Committee (s), Gram Sabha (s), Sub-Division Level Committee (s) and the District Level Committee are enclosed as annexure.....to.....annexure.....(**Not Applicable**)
- (b) The diversion of forest land for facilities managed by the Government as required under section 3 (2) of the FRA have been completed and the Grama Sabhas have given their consent to it; (**Not Applicable**)
- (c) The proposal does not involve recognized right of Primitive Tribal Groups and Pre-agricultural communities.

**Signed by Khanindra
Choudhury**

Date: 03-06-2023 17:27:08

(Shri Khanindra Choudhury, IAS)
Deputy Commissioner,
Goalpara

FORM-1
(For linear project)

GOVERNMENT OF ASSAM
OFFICE OF THE DISTRICT MAGISTRATE: KOKRAJHAR
(MAGISTRACY BRANCH)

No.E-34035/102

Dated, Kokrajhar the 14th November' 2024.

TO WHOMSOEVER IT MAY CONCERN

In compliance of Ministry of Environment and Forest (MoEF), Government of India's No.11-9/98-FC(pt.) dated 3rd August' 2009 wherein the MoEF issued guidelines on submission of evidences for having initiated and completed the process of settlement of rights under the Schedule Tribes and Other Traditional Forest Dwellers (Recognition of Forest Rights) Act, 2006 (FRA, for short on the forest land proposed to be diverted for non-forest purposes read with MoEF's letter dated 5th February 2013 wherein MoEF issued certain relaxation in respect of linear project, it is certified that 0.666 Hectares of forest land proposed to be diverted in favour of Chief Manager, Nangalbibra-Bongaigaon Transmission Limited (name of user agency) for construction of 400KV D/C Bongaigaon Transmission Line (purpose for diversion of forest land) in Kokrajhar district falls within jurisdiction of Satbhendi village (s) under No.2 Satbhendi RF under Nayekgaon Range under DFO, Haltugaon Division in Kokrajhar thehsils.

It is further certified that:

(a)The complete process for identification and settlement of rights under the FRA has been carried out for the entire 0.666 hectares of forest area proposed for diversion. A copy of records of all consultations and meetings/NOC of the forest Rights Committee, Gram Sabha, Sub-Division Level Committee, Bodoland Territorial Council (BTC) are enclosed as annexure 1 to V.

(b)The diversion of forest land for facilities managed by the Government as required under section 3(2) of the FRA have been completed and the Gram Sabha, SDLC and BTC have given their consent to it.

(c)The proposal does not involve recognized rights of Primitive Tribal groups and Pre agriculture communities.

Signed by
Masanda Magdalin Pertin
District Magistrate
Date: 14/11/2024 17:21:00
District Magistrate
Kokrajhar

FORM-I

(for linear projects)
Government of Assam
Office of the Deputy Commissioner,
Goalpara

No. Rev/1487/2023-REV-GLP/71

Dated : 03rd June, 2023

TO WHOM SO EVER IT MAY CONCERN

In compliance of the Ministry of Environment and Forests (MoEF), Government of India's letter No.11-9/98-FC(pt.) dated 3rd August, 2009, wherein the MoEF issued guidelines on submission of evidences for having initiated and completed the process of settlement of rights under the Scheduled Tribes and Other Traditional Forest Dwellers (Recognition of Forest Right) Act, 2006 ('FRA', for short) on the forest land proposed to be diverted for non-forest purposes read with MoEF's letter dated 5th February, 2013, wherein MoEF issued certain relaxation in respect of linear projects, it is certified that 41.747 hectares of forest land proposed to be diverted in favour of Sterlite Power for Construction of 400 KV D/C Bongaigaon-Nangalbibra Transmission Line in Goalpara district falls within jurisdiction of Pancharatna Hill RF, Bagulamari PRF, Sagunbahi RF, Rakhyasini PRF and Zangrajangsa RF under Balijana Tehsil.

It is further certified that:

- (a) The complete process for identification and settlement of rights under the FRA has been carried out for the entire.....hectares of forest area proposed for diversion. A copy of records of all consultations and meetings of the Forest Rights Committee (s), Gram Sabha (s), Sub-Division Level Committee (s) and the District Level Committee are enclosed as annexure.....to.....annexure.....(**Not Applicable**)
- (b) The diversion of forest land for facilities managed by the Government as required under section 3 (2) of the FRA have been completed and the Grama Sabhas have given their consent to it; (**Not Applicable**)
- (c) The proposal does not involve recognized right of Primitive Tribal Groups and Pre-agricultural communities.

**Signed by Khanindra
Choudhury**

Date: 03-06-2023 17:27:08

(Shri Khanindra Choudhury, IAS)
Deputy Commissioner,
Goalpara

Forest Land Boundary Demarcation by Concrete Pillers



Three Layer Protection Measures implemented on Towers at Bhairab Forest to Restrict Climbing of Arboreal Animals

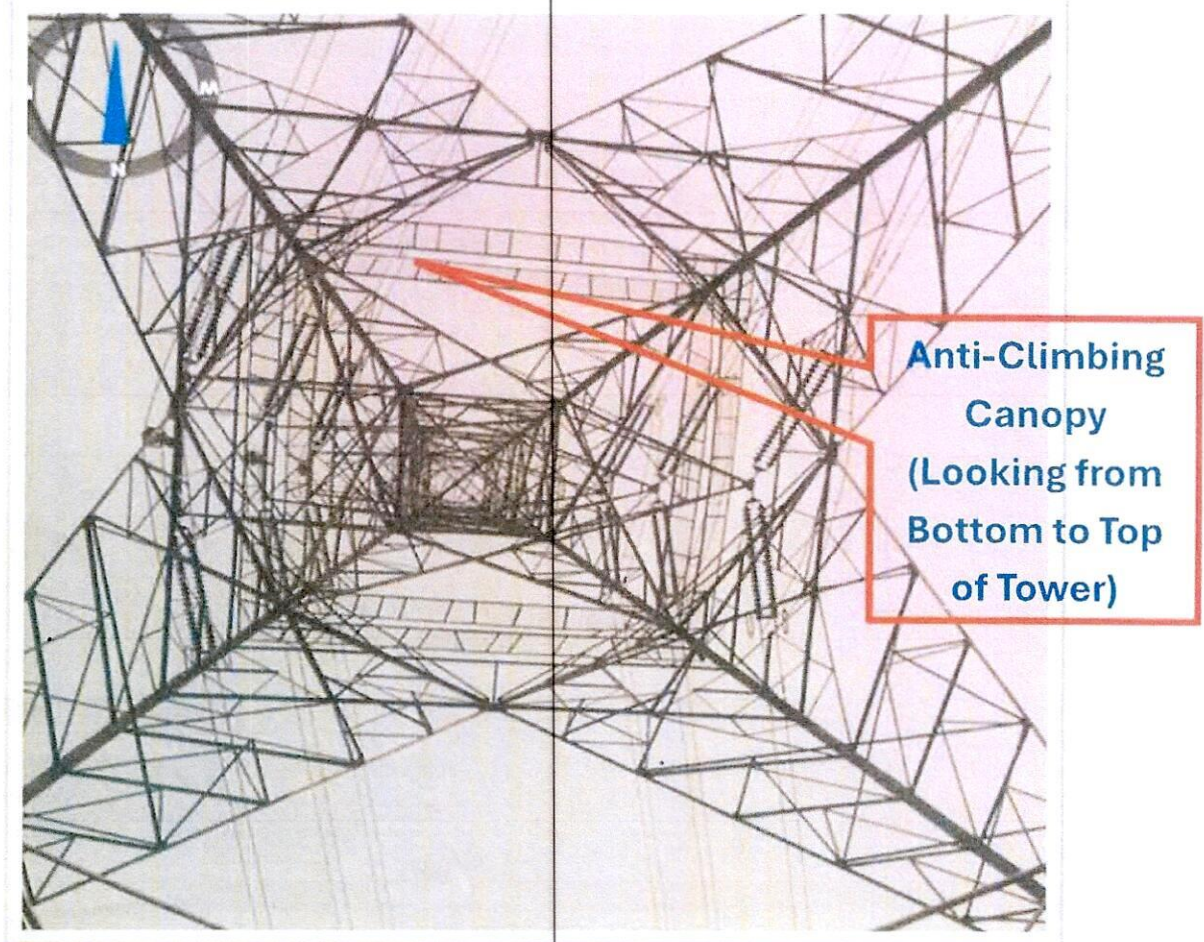
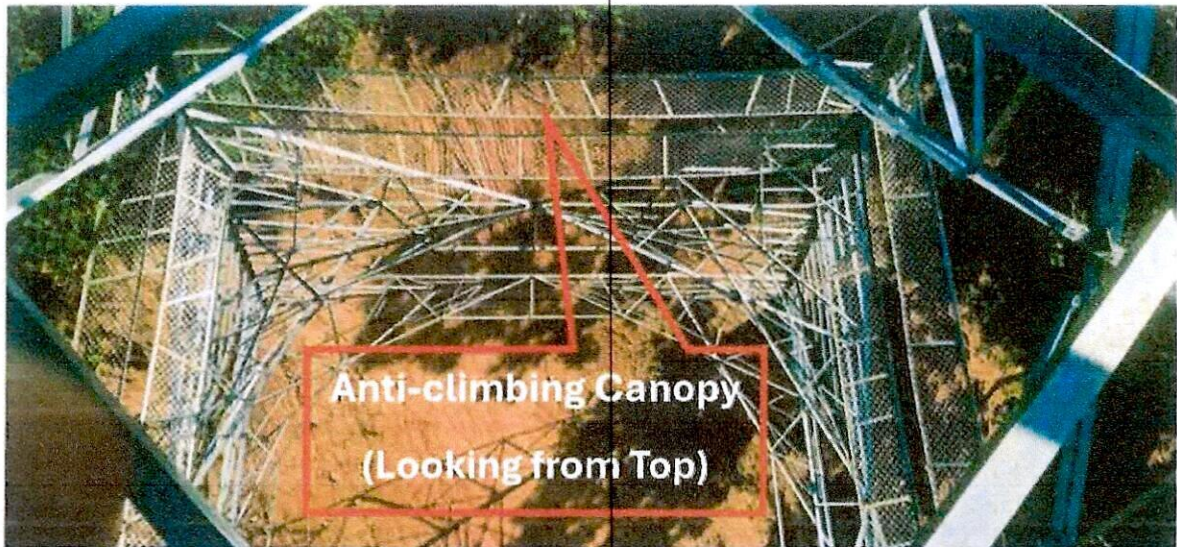

Quinty

Three Layer Protection Measures implemented on Towers at Bhairab Forest to Restrict Climbing of Arboreal Animals

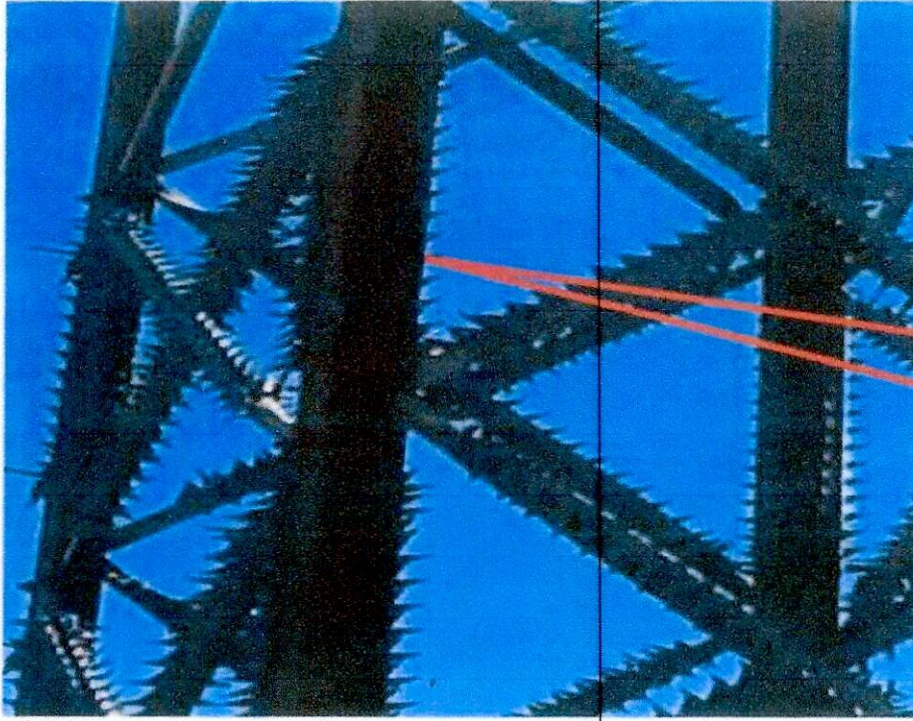

**Anti-Climbing
Guards**



**Anti-Climbing
Device with
Barbed wire
Fencing**

Apr 15, 2024 2:22:25 PM

Bird Deflectors Installed on Upper Conductor of Transmission Line in Forest Land.

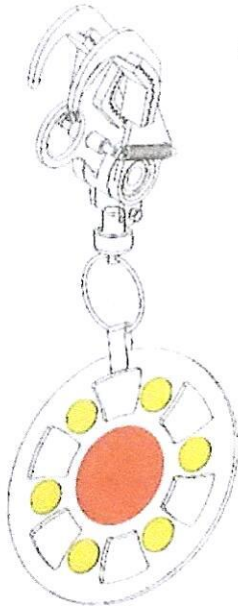

| Sr. No | PART Description (BOM) | Description | QTY |
|--------|------------------------|--|-----|
| A | UNIVERSAL CLAMP | High Grade Engineering Polymer | 1 |
| B | CONNECTING ROD | STAINLESS STEEL - corrosion free | 1 |
| C | HIGH TENSILE SPRING | STAINLESS STEEL - corrosion free | 2 |
| D | HOLDING SHAFT | STAINLESS STEEL - corrosion free | 2 |
| E | ROTATING MECHANISM | Self lubricating ball bearing With High Grade Engineering Polymer Case Cover | 1 |
| F | FLAPPER Ø195MM | High grade engineering Polymer | 1 |

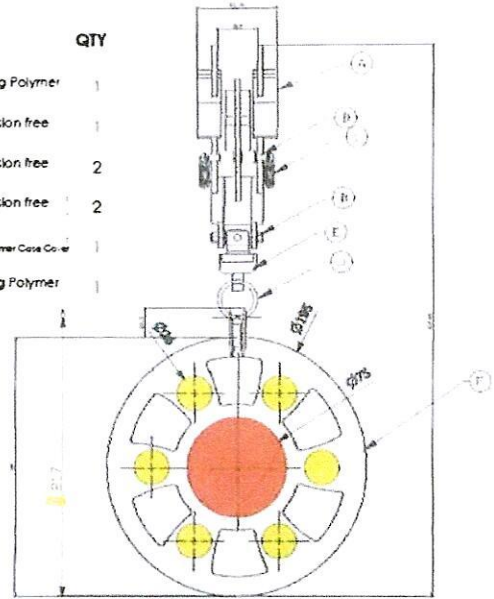

Bird Deflector installed on top conductor

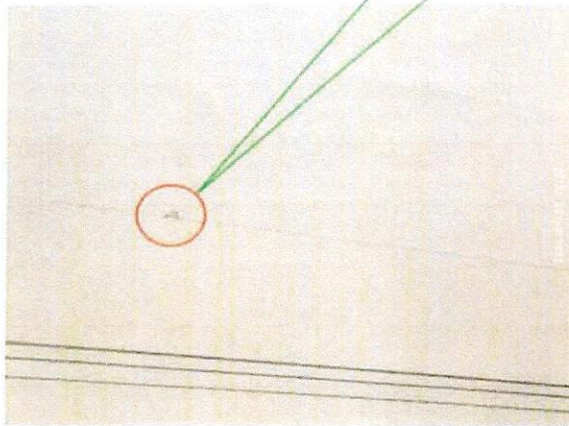

Bird Deflector installed on top conductor

